

play your life,
play it differently

The Italian bathroom.

URBAN PLAY	PAGE 2
MINIMAL PLAY	PAGE 38
DECOR PLAY	PAGE 88
CITY PLAY	PAGE 120

QUEEN VICTORIA
STREET EC4

103

beauty is
in the eyes
of **beholder.**

Johann Wolfgang Goethe

La bellezza è negli occhi di chi guarda. Johann Wolfgang Goethe
Beauty is in the eyes of the beholder. Johann Wolfgang Goethe
La beauté est dans les yeux de celui qui regarde. Johann Wolfgang Goethe



*Sulle basi lavabo a struttura metallica, è possibile installare mensoloni con vasca integrata o lavabi in appoggio.
Washbasin units with a metal structure can be fitted with tops featuring integrated or standing basins.
Sur les éléments sous-vasque avec piètement métallique, il est possible d'installer des plans de toilette épais H.6 ou H.10 cm avec vasque intégrée ou bien avec vasque à poser.*

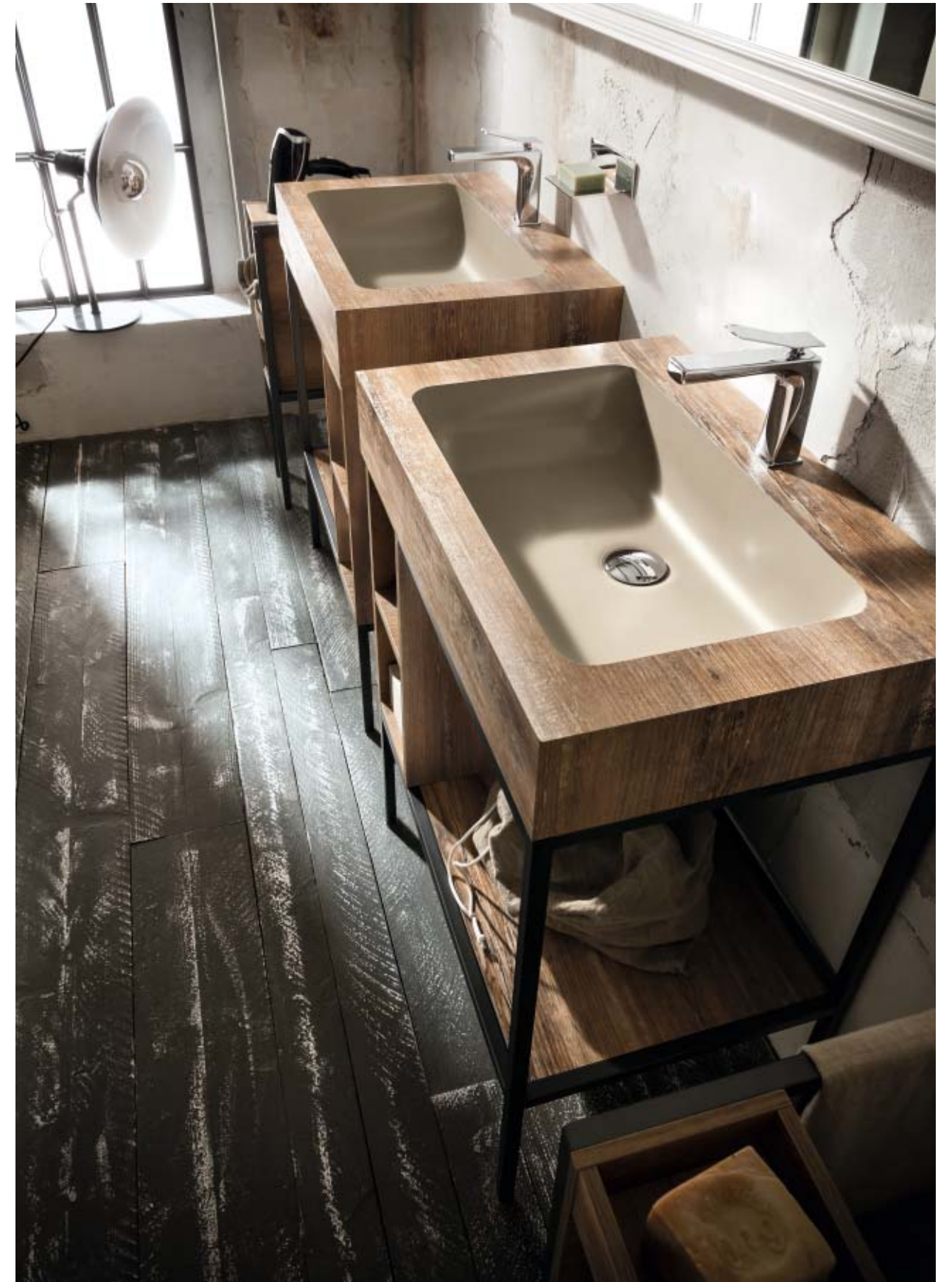





I pratici portasciugamani da terra, sono disponibili nella versione con piano contenitore o porta phon.
The practical floor-standing storage units with towel rails are available either with a top shelf or hairdryer holder.
Les pratiques porte-serviettes sur pied existent en version avec rangement ouvert ou support sèche-cheveux sur le dessus.

La cornice sagomata dello specchio, laccata bianca opaca, si armonizza perfettamente con lo stile "industrial".
The moulded mirror frame in matt bianco lacquer suits the urban style of this bathroom perfectly.
L'encadrement mouluré laqué blanc mat du miroir s'harmonise parfaitement avec le style « urban ».







Il lavabo Martin, realizzato in deimos-stone, è disponibile in tre tinte e può essere richiesto con o senza alzata che consente di alloggiare il miscelatore a parete. L'elegante tavoletta completa il lavabo.
The Martin laundry basin is made from Demos-stone and is available in three colours, with or without a wall panel used to install a wall mounted mixer tap. An elegant scrubbing board completes this basin.
La vasque Martin réalisée en deimos-stone existe en trois teintes au choix et peut être demandée avec ou sans dossier. Ce dernier permet de loger le mitigeur mural. La vasque est également dotée d'une élégante tablette de dépose.

La nuova maniglia in tinta antracite, è coordinata al colore ed allo stile "urban" della struttura in metallo.
The new antracite coloured handle is coordinated with the colour and the industrial style of the metal structure.
La nouvelle poignée teinte Antracite est coordonnée à la couleur et au style « industrial » du piètement en métal.

Le colonne con mensola a giorno e appendiabiti, sono disponibili in cinque varianti di colore per la struttura ed in tutte le finiture del mobile per i ripiani.
The structures of the full-height open and clothes hanging units are available in five colour options while the finish of the shelves can be chosen from all our furniture finishes.
Les colonnes ouvertes avec tablettes ou tringle de penderie peuvent avoir la structure déclinée en cinq coloris et les tablettes dans toutes les finitions du meuble.



L'innovativa lampada a sospensione con movimento "sali e scendi", su disegno esclusivo Cerasa, si presta per essere collocata non solo nel bagno ma anche in ogni altro ambiente della casa.

The innovative pendant pulley lamp has been designed exclusively by Cerasa and is perfect for any room in the home, not just the bathroom.

L'innovante suspension à poulie du type « monte et baisse », réalisée sur dessin exclusif Cerasa, pourra être installée tant dans une salle de bains que dans d'autres pièces de l'habitation.

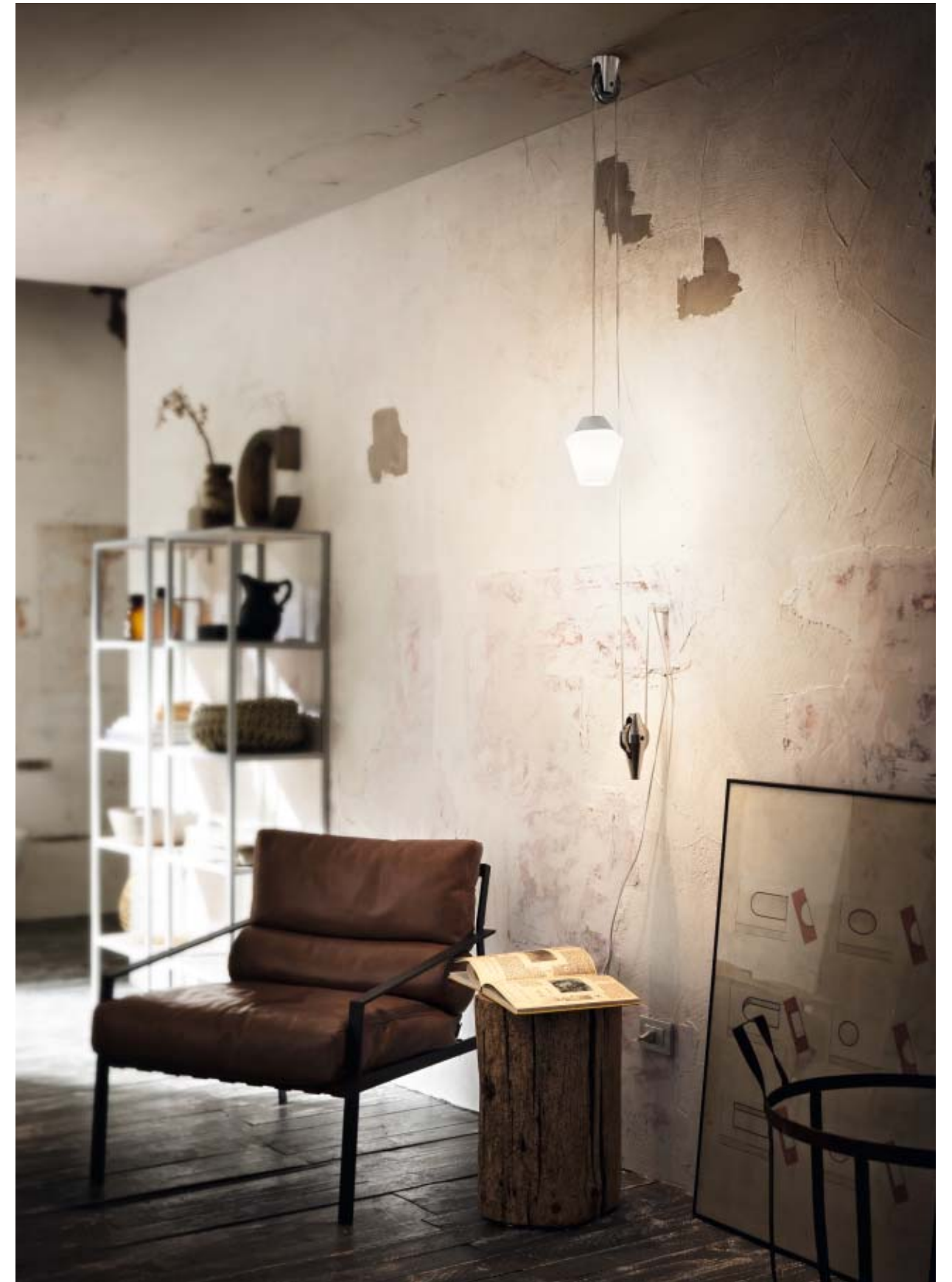



***I am
obsessed
with beauty.***

Robert Mapplethorpe



*Sono ossessionato dalla bellezza. Robert Mapplethorpe
I am obsessed with beauty. Robert Mapplethorpe
Je suis obsédé par la beauté. Robert Mapplethorpe*



*La lampada da terra, su disegno esclusivo Cerasa, può essere arricchita da un pratico servetto porta oggetti e asciugamani.
The floor lamp designed exclusively by Cerasa can be fitted with a practical shelf and towel rail.
Le lampadaire sur pied, sur dessin exclusif Cerasa, peut être enrichi d'une tablette avec porte-serviettes très fonctionnelle.*









*Per la lampada a sospensione con movimento "sali e scendi", è prevista l'alimentazione elettrica sul retro dello specchio.
The pendant pulley lamp is connected to the mains behind the mirror.
Pour la suspension à poulie du type « monte et baisse », l'alimentation électrique a été prévue au dos du miroir.*



*Il piano d'appoggio inferiore, ha misure variabili in funzione delle dimensioni delle basi che vengono utilizzate.
The size of the bottom shelf varies depending on the dimensions of the base units used.
Les dimensions du plan inférieur peuvent varier en fonction des dimensions des éléments bas choisis.*

*In alternativa al lavabo Martin, è possibile utilizzare qualsiasi altro tipo di mensolone con vasca integrata.
Any type of top with an integrated basin can be used instead of the Martin laundry basin.
À la place de la vasque Martin, il est possible d'utiliser n'importe quel autre type de plan de toilette épais H.6 ou H. 10 cm avec vasque intégrée.*







*La plafoniera a soffitto completa la serie di lampade su disegno esclusivo di Cerasa, creando un coordinato prezioso ed unico per l'arredo dell'ambiente bagno e non solo.
The ceiling light completes the light fixtures designed exclusively by Cerasa: a precious, unique and coordinated line that is perfect for the bathroom and beyond.
Le plafonnier complète la série des luminaires sur dessin exclusif Cerasa, en créant une série coordonnée précieuse et unique pour la décoration de la salle de bains ou d'autres pièces.*





*a thing
of beauty is
a joy forever.*
John Keats

*Una cosa di bellezza è una cosa per sempre. John Keats
A thing of beauty is a joy forever. John Keats
Une chose de beauté est une joie éternelle. John Keats*





*L'elemento angolare con penisola bifacciale, è contenitivo su entrambi i lati.
The corner unit with its two-sided peninsula unit can be accessed for storage from both sides.
L'agencement en angle avec un élément en épi double face permet d'accéder des deux côtés du meuble.*

beauty is
eloquent even
when silent.

François des Rues



La bellezza è un'eloquenza muta. François des Rues
Beauty is eloquent even when silent. François des Rues
La beauté est une éloquence muette. François des Rues



La nuova vasca integrata al piano in ocritec color tortora, abbinato alla finitura legno industrial, è completata dalla piletta quadrata sempre in ocritec.

The new tortora coloured Ocritec basin integrated in the industrial wood finish top is completed by a square, Ocritec waste plug.

La nouvelle vasque intégrée au plan de toilette finition essence Industrial est réalisée en ocritec coloris Tortora et dispose d'une bonde de vidage carrée réalisée, elle aussi, en ocritec.

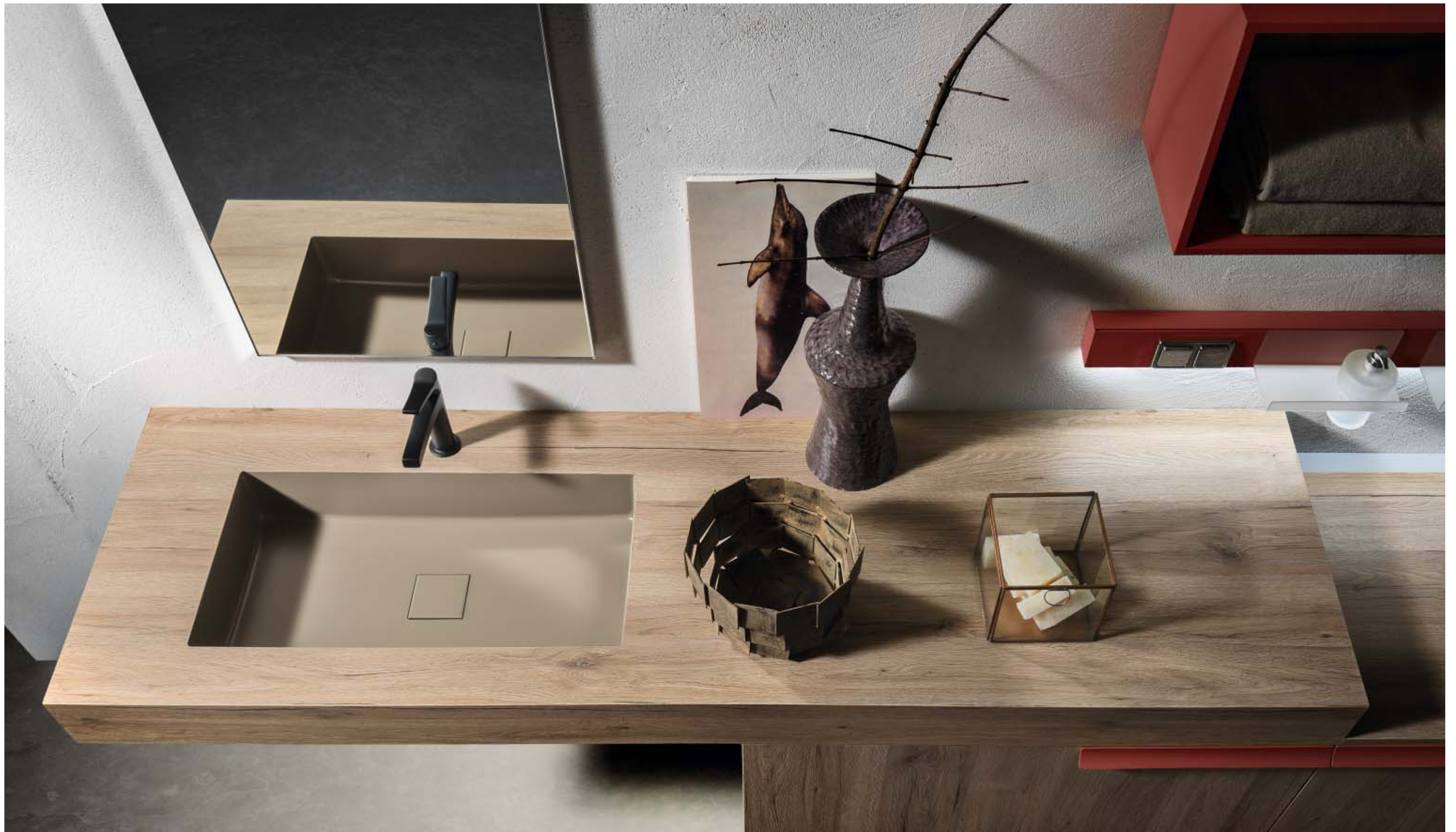



I mensoloni sono disponibili in molteplici finiture, fra cui l'ecomalta, proposta in ben sei colori. Possono essere accessoriati con un pratico portasciugamano.
The tops are available in many finishes including Ecomalta, available in all of six colours. They can be fitted with a practical towel rail.
Les plans de toilette H.6 ou H.10 cm sont disponibles dans de multiples finitions parmi lesquelles la finition ecomalta proposée en six coloris. Ils peuvent être équipés d'un pratique porte-serviettes.

Massima personalizzazione per i vani a giorno di spessore ridotto: su richiesta è infatti possibile diversificare le finiture tra scocca e schiena.
The slim open-fronted units benefit from the utmost degree of customisation: if desired, their back panels and carcasses are available in different finishes.
Personnalisation maximale pour les éléments ouverts dont le caisson a une épaisseur fine : en effet, il est possible de demander à ce que le caisson et le fond aient une finition diversifiée.





*In alternativa alla base lavabo, è possibile utilizzare il lavabo
in appoggio Diago, realizzato in tecnoril bianco opaco.
The Diago standing basin, made from matt white Tecnoril,
can be installed instead of a washbasin unit.
À la place de l'élément sous-vasque, on pourra utiliser une
vasque haute à poser Diago réalisée en tecnoril blanc mat.*

*I mensoloni sono disponibili in due altezze: 6 e 10 cm.
The tops are available in two different heights: 6 and 10 cm.
Les plans de toilette épais sont disponibles en deux différentes
hauteurs : 6 et 10 cm.*





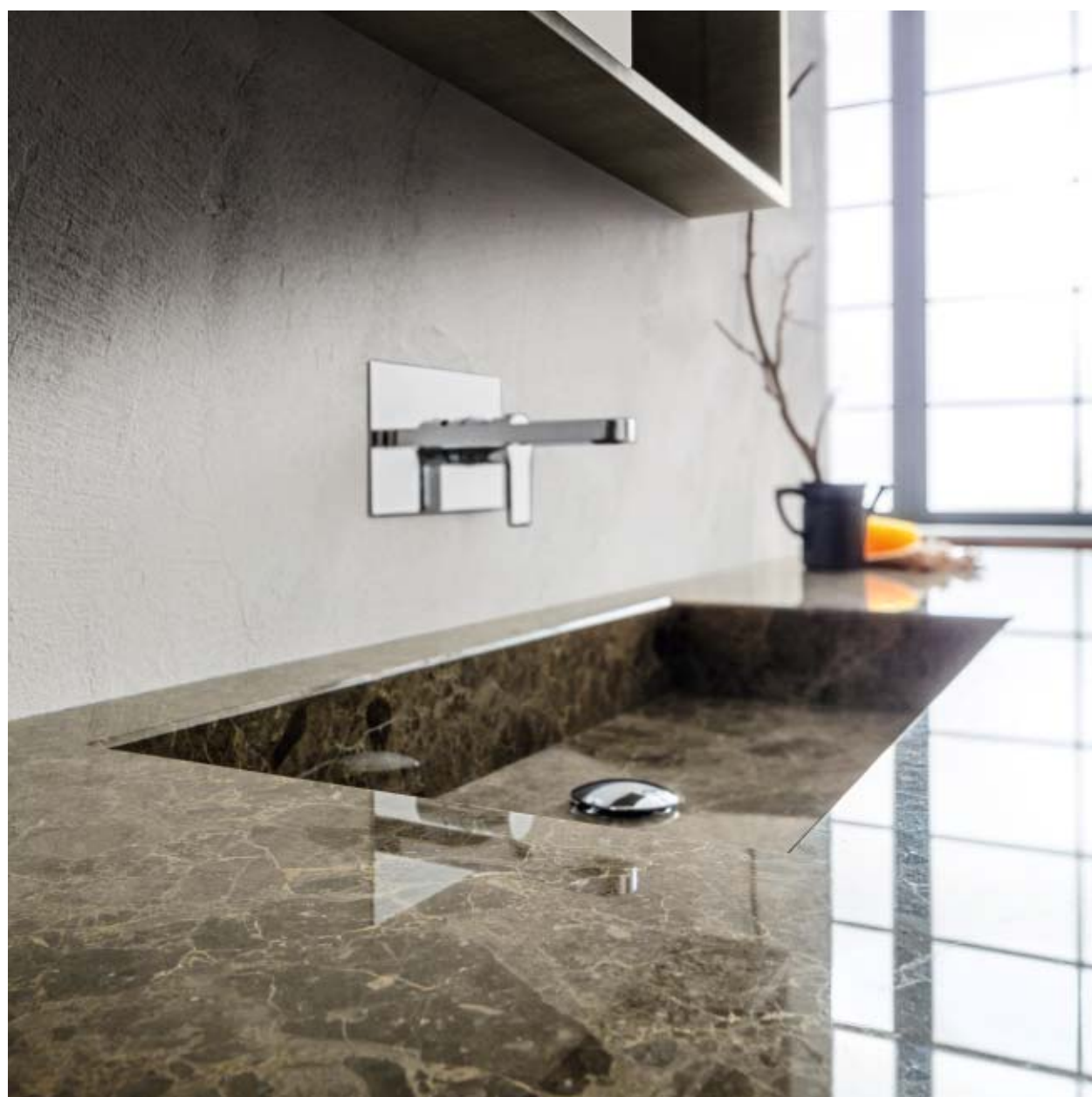

Con alcuni marmi è possibile realizzare il top con vasca integrata costruita nello stesso materiale, sia nella versione piano che come mensolone.

With some types of marble it is possible to integrate the basin in a slim or thick top made of the same material.
Avec certains marbres, il est possible de réaliser le plan de toilette dans les différentes hauteurs disponibles, avec vasque collée et intégrée, réalisée dans le même matériau.



**All things have
beauty, but not
everyone sees it.**

Confucio



*Ogni cosa ha la bellezza, ma non tutti la vedono. Confucio
All things have beauty, but not everyone sees it. Confucio
Toutes les choses ont leur beauté, mais tout le monde ne sait pas les voir. Confucio*





*La lampada con paralume in metallo è disponibile in versione
applique laterale per specchio, oppure come sospensione a
soffitto.
This light with a metal lampshade can be installed either on
the side edge of the mirror or hung from the ceiling.
La lampe avec abat-jour en métal existe soit en version spot
latéral pour miroir soit en version suspension.*



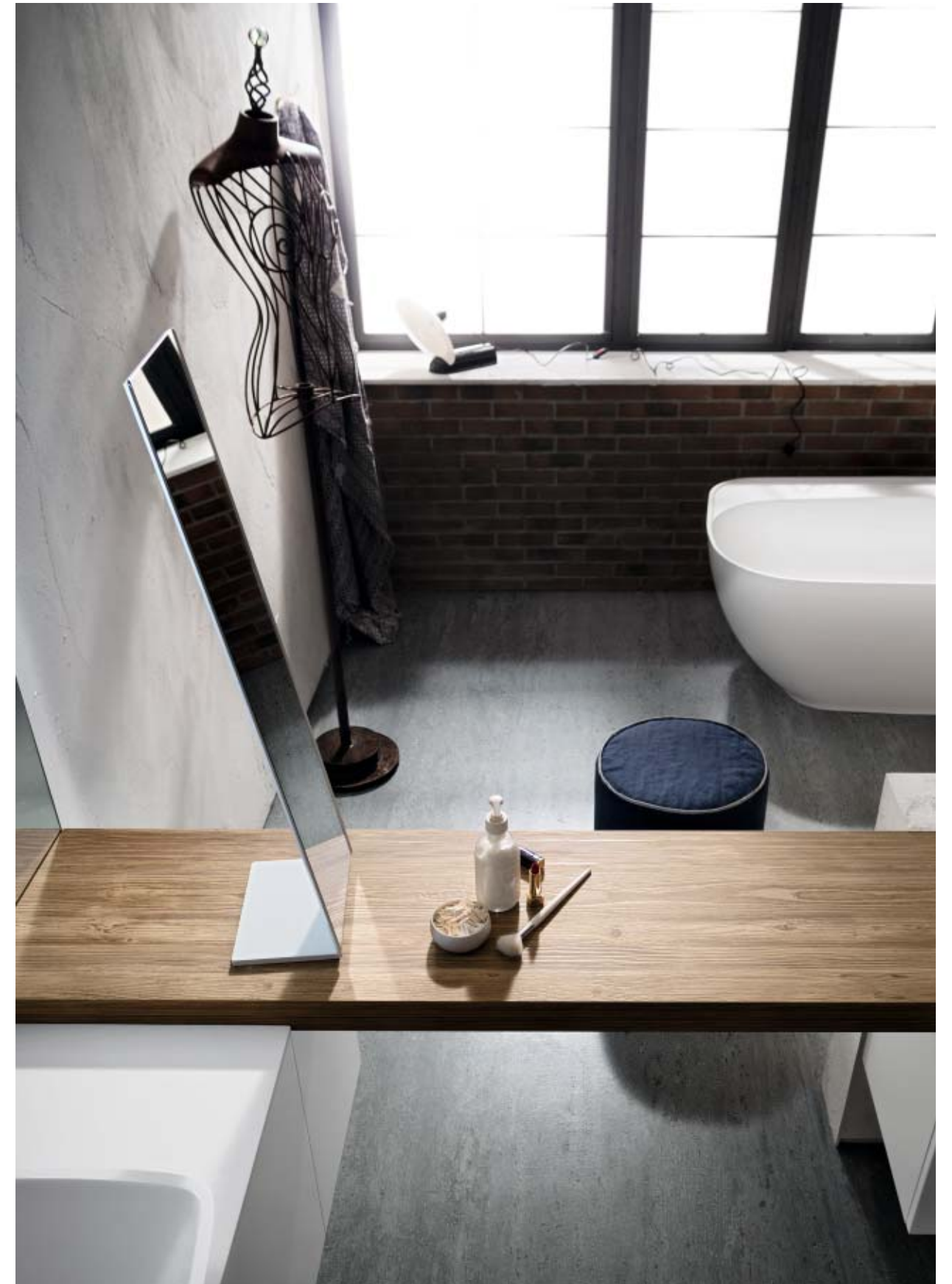



beauty is
visibile, charm is
something felt.
Roberto Gervaso



La bellezza si vede. Il fascino si sente. Roberto Gervaso
Beauty is visible, charm is something felt. Roberto Gervaso
La beauté se voit. Le charme se sent. Roberto Gervaso

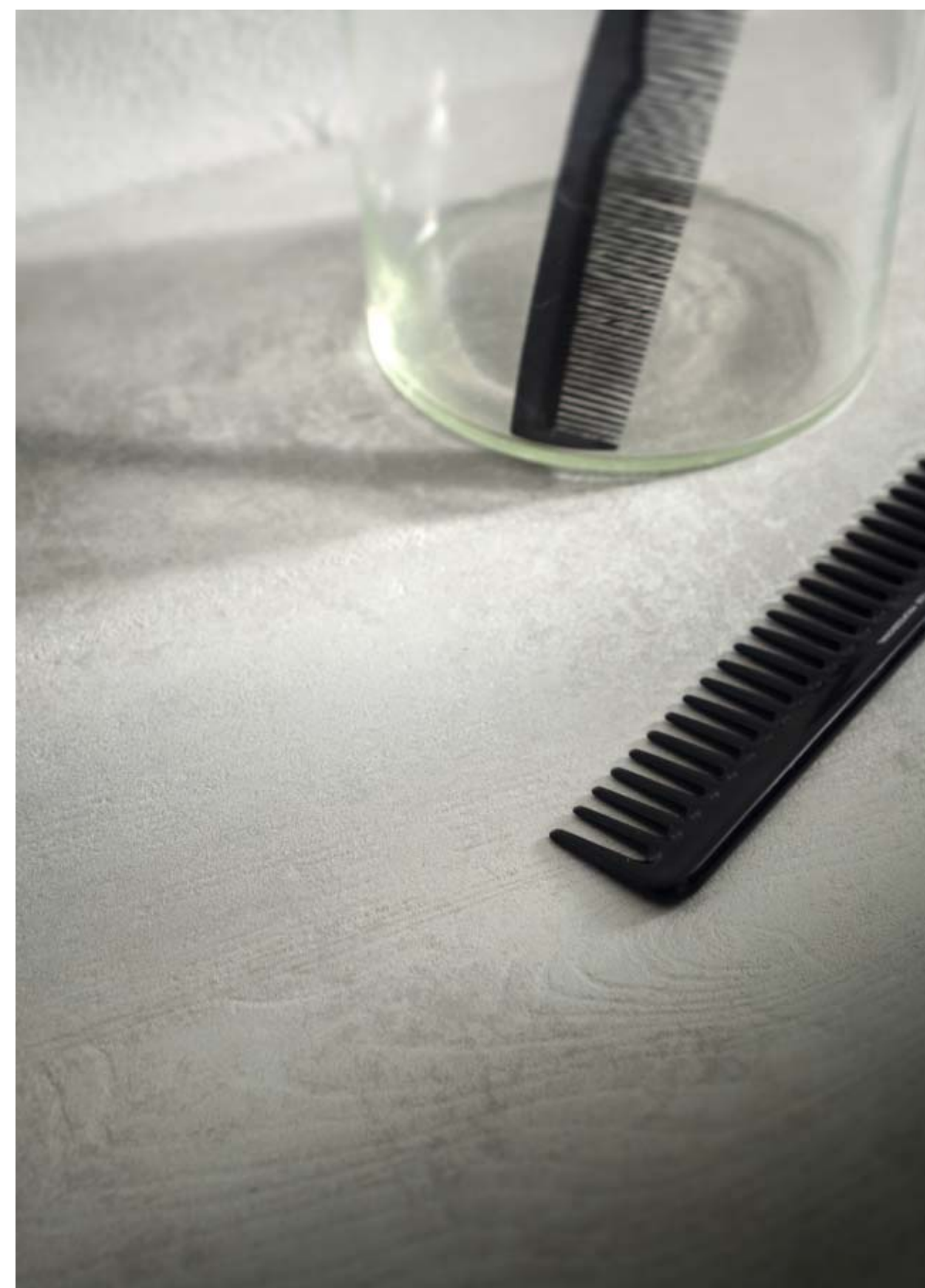

*La maniglia Man020 viene laccata opaca, nella stessa tinta del mobile.
The Man020 handle is matt lacquered to match the colour of the unit.
La poignée Man020 est laquée mate dans la même teinte que le meuble.*





*I vani a giorno in lamiera possono essere ruotati di 360°, per creare configurazioni sempre diverse.
The open-fronted, sheet metal units can be turned upside down to create layouts that are never repetitive.
Les éléments ouverts en tôle peuvent tourner sur 360° afin de créer des configurations toujours différentes.*

*L'ecomalta, utilizzata per creare sia top che mensoloni, è disponibile in 6 varianti di colore: nebbia, fango, beige, sand, argilla e talco.
Ecomalta is used to create slim and thick tops and is available in 6 colour options: nebbia, fango, beige, sand, argilla and talco.
La finition ecomalta utilisée pour créer les plans de toilette dans les différentes hauteurs disponibles est déclinée en 6 coloris : Nebbia, Fango, Beige, Sand, Argilla et Talco.*

MINIMAL PLAY





*Gli interni dei cassetti possono essere accessoriati con luci,
tappetini, elementi divisori o contenitivi.
Drawer interiors can be fitted with lights, mats, dividers or
containers.
L'intérieur des tiroirs peut être aménagé avec un éclairage,
un tapis de protection, des séparateurs ou des boîtes de
rangement.*

*Fianchi e fondi di riparto arricchiscono la composizione,
rendendola ancora più raffinata.
Lay-on side panels and bottom panel liners beautify the layout
giving it an additional touch of refinement.
Des joues et des dessous de finition enrichissent la composition
dont l'esthétique devient encore plus raffinée.*

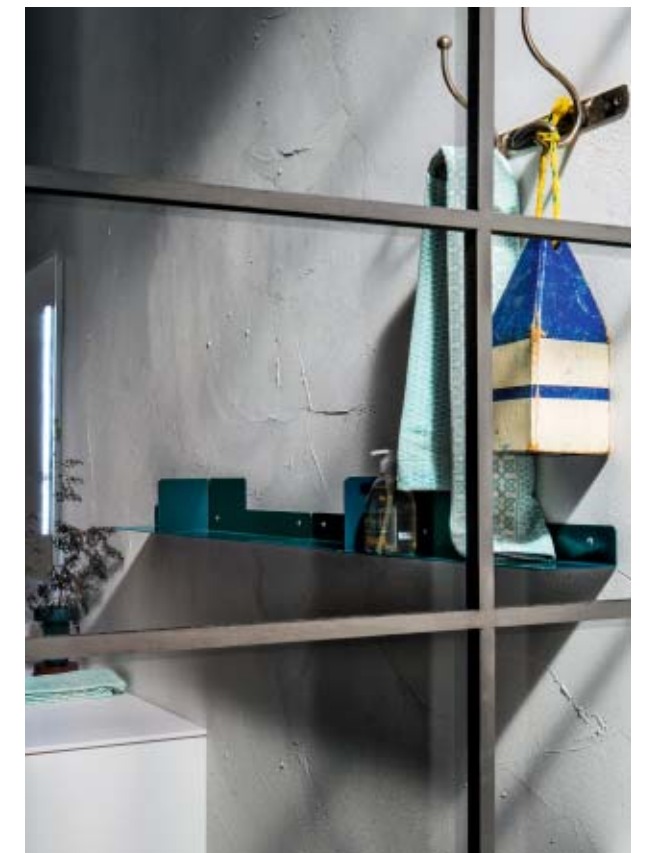



beauty is
only a promise
of **happiness.**

Stendhal

La bellezza non è che una promessa di felicità. Stendhal
Beauty is only a promise of happiness. Stendhal
La beauté n'est que la promesse du bonheur. Stendhal





*Il piedino cromato puo' essere utilizzato come sostegno, oppure come semplice elemento decorativo.
The chromed foot can be used to support the unit or as a mere embellishment.
Le pied chromé peut être utilisé soit comme support soit comme simple élément décoratif.*

*Il lavabo Cerchio, realizzato in marmoresina bianco opaco o lucido, ha un design pulito ed elegante che ben si abbina agli stili più diversi.
The circular Cerchio basin made from matt or gloss engineered marble has a sleek and elegant design that goes well with many different styles.
La vasque Cerchio réalisée en marbre de synthèse blanc mat ou brillant a un design net et élégant qui s'allie parfaitement aux styles les plus divers.*







Il raffinato specchio con cornice ovale è disponibile in cinque colorazioni opache: bianco, tortora, grigio chiaro, grigio scuro e ghisa.
The refined, oval, framed mirror is available in five matt colours: bianco, tortora, grigio chiaro, grigio scuro and ghisa.
Le miroir raffiné avec encadrement ovale est disponible en cinq coloris mats : Bianco, Tortora, Grigio chiaro, Grigio scuro et Ghisa.



unity
is the form
of all *beauty.*

Saint Augustine

L'unità è la forma di tutta la bellezza. Sant'Agostino
Unity is the form of all beauty: Saint Augustine
L'unité est la forme de toute beauté. Saint-Augustin



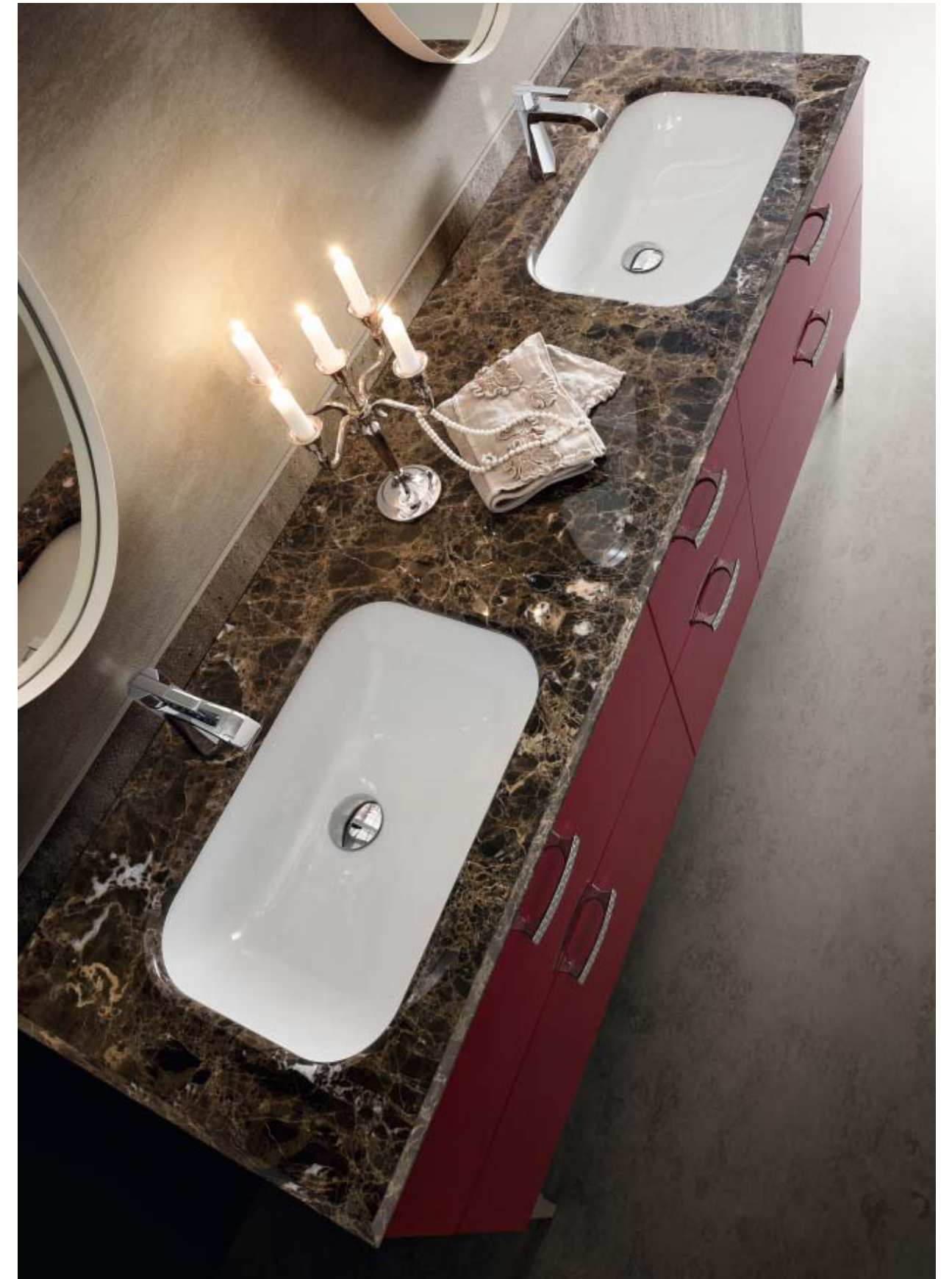

*In alternativa al piano con vasca integrata in tecnoril, l'intramontabile soluzione con piano in marmo e lavabo sottopiano.
 Instead of a Tecnoril top with integrated basins, a timeless alternative with a marble top and under counter basins is shown here.
 À la place du plan de toilette avec vasque intégrée en tecnoril, on pourra opter pour une indémodable solution avec plan de
 toilette en marbre et vasque sous plan.*





*La forma ovale del lavabo in marmoresina Anya rende armonica l'intera composizione.
The oval shape of the Anya engineered marble washbasin adds harmony to the entire layout.
La forme ovale de la vasque Anya en marbre de synthèse rend la composition très harmonieuse.*



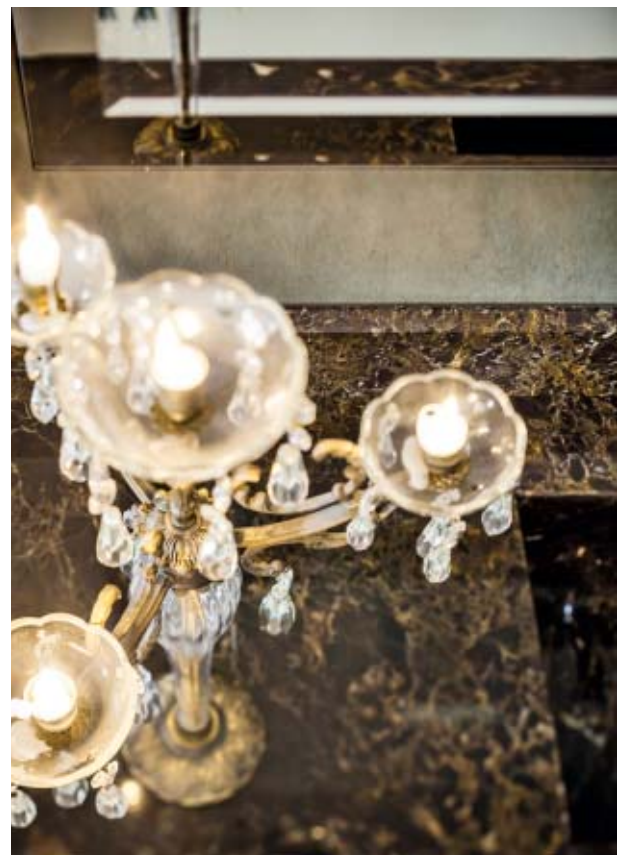
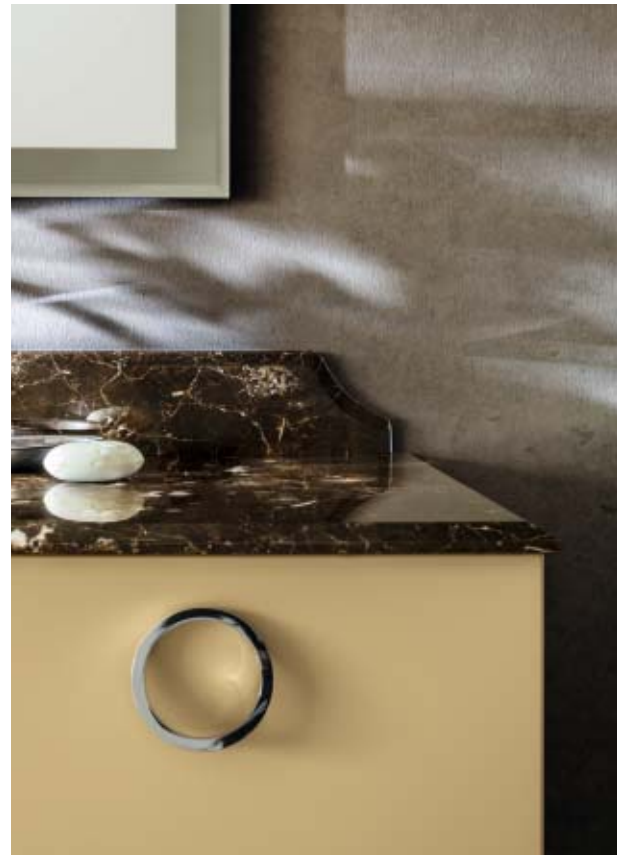

*La vasca costruita in marmo emperador dark con larghezza 80 cm, puo' accogliere uno o due miscelatori.
The 80-cm wide Emperador Dark marble basin can accommodate one or two mixer taps.
La vasque collée et intégrée de 80 cm de large est réalisée en marbre Emperador dark et peut recevoir un ou deux mitigeurs.*





*Lo specchio inciso e bisellato rende preziosa l'intera
composizione.
The etched and bevelled mirror adds a special, precious touch
to the whole layout.
Le miroir gravé et biseauté enrichit toute la composition.*





Le lampade da parete con paralume in tessuto e lo specchio accoppiato con fondo brunito, completano l'arredo della stanza da bagno.
The wall lights with their fabric lampshades and the mirror with its burnished back panel complete the look of this bathroom.
Les appliques murales avec abat-jour en tissu et le miroir fixé à un panneau bruni complètent l'ameublement de cette salle de bains.



Beauty comes
for virtue, not
from riches.

Socrates

Non dalle ricchezze ma dalle virtù nasce la bellezza. Socrate
Beauty comes for virtue, not from riches. Socrates
Ce ne sont pas des richesses que naît la beauté, mais des vertus. Socrate



*Alle strutture in metallo è possibile aggiungere l'elemento portasciugamano laterale.
A side towel rail can be added to the metal structures.
Il est possible de fixer un élément porte-serviettes sur le côté des piètements en métal.*

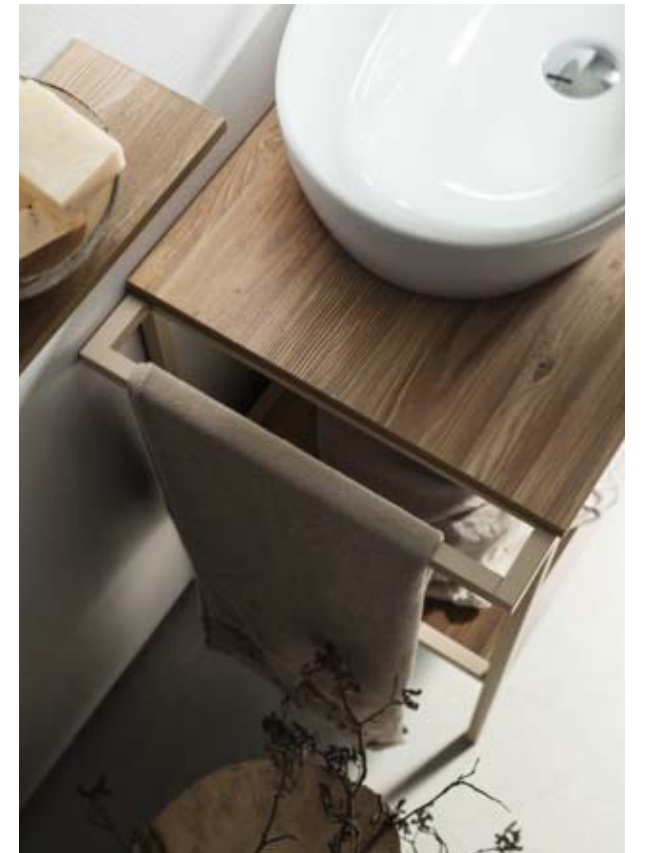





*Lo specchio contenitore a vasistas è previsto nella versione semplice o nella versione plus, dove è arricchito con schiena "a specchio" ed illuminazione interna e sul fondo.
The mirror cabinet with a stay-lift door is available in the standard or plus version. The latter has the additional advantage of a mirrored back panel and interior and bottom panel lighting.
L'armoire de toilette avec porte miroir relevable est prévue soit en version simple soit en version plus qui se distingue par un fond miroir et par un éclairage à l'intérieur et dans le bas du meuble.*

*I cassetti sono realizzati con struttura metallica e guide ammortizzate.
The drawers have a metal structure and soft-close runners.
Les tiroirs sont réalisés avec une structure métallique montée sur des coulisses avec amortisseur de fermeture.*

*I moduli sospesi sono stati implementati con la nuova altezza da 24 cm.
Wall-hung modules are now also available 24 cm high.
Les modules suspendus ont une nouvelle hauteur de 24 cm.*

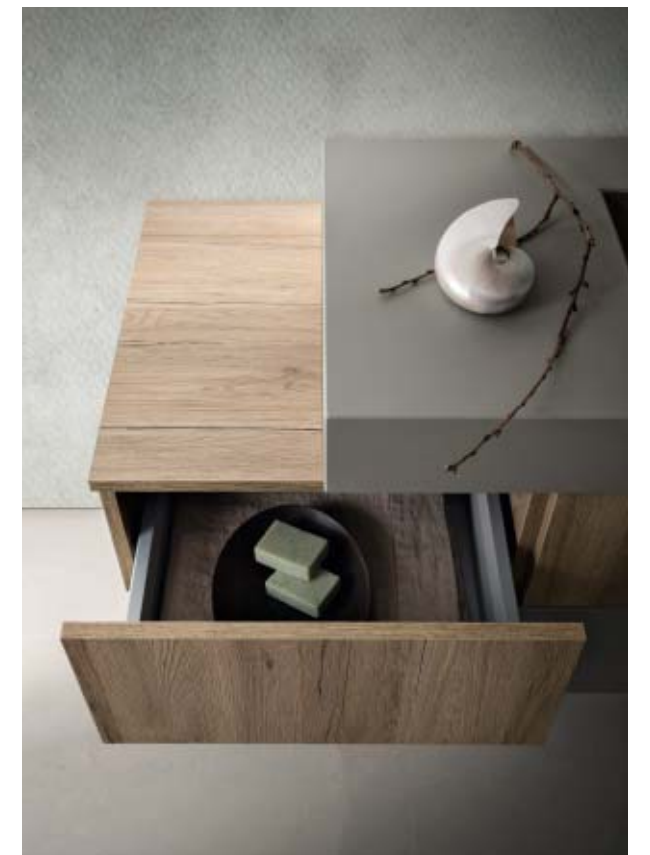





nothing is
beautiful from
every point
of view. *Homer*

Niente è bello sotto tutti i punti di vista. Omero
Nothing is beautiful from every point of view. Homer
Rien n'est beau sous tous ses aspects. Homère





L'inconsueto modulo a giorno si inserisce nelle basi creando un esclusivo gioco di pieni e vuoti, garantendo un pratico contenimento sempre a vista.

When fitted into base units, this original open-fronted unit creates an exclusive effect achieved by alternating full and empty spaces.

L'insolite module ouvert s'intègre aux éléments bas en créant un jeu de pleins et de vides exclusif et en offrant un pratique rangement apparent.

Combinando insieme pensili di misure e forme diverse, si possono creare varie tipologie di colonne.

Various types of full-height units can be created by combining wall units of different sizes and shapes.

En associant des éléments hauts de différentes formes et dimensions, on pourra créer des colonnes personnalisées.





*Per chi ha problemi di spazio, è disponibile il piano con vasca
integrata in soli 36.5 cm di profondità.
A 36.5 cm deep top with an integrated basin is the perfect
solution for homes where space is at a premium.
Pour ceux qui ont des problèmes d'espace, il existe le plan
de toilette avec vasque intégrée de 36,5 cm de profondeur
seulement.*

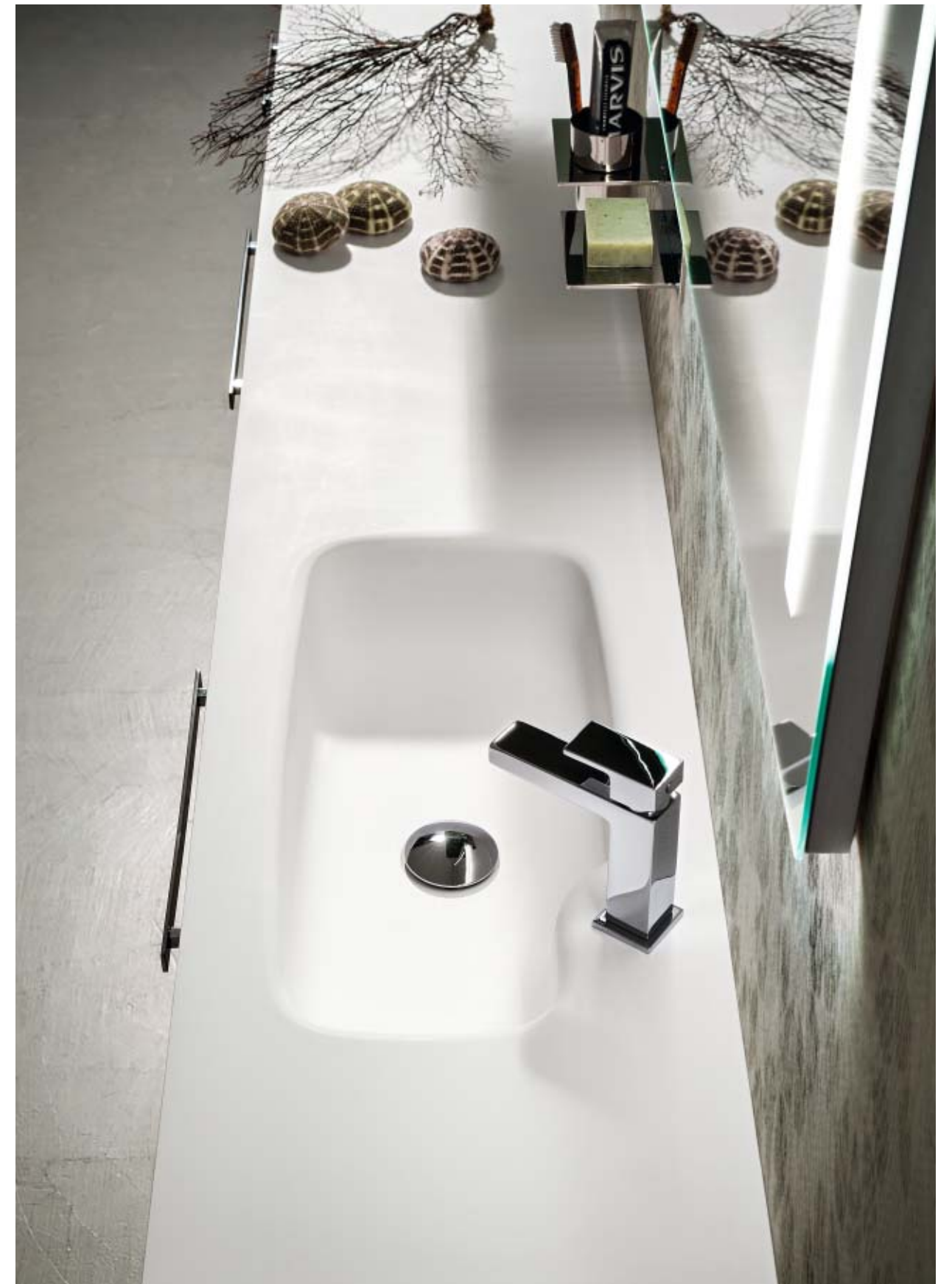





*La vasca Soft in tecnoril è disponibile in tre versioni.
The Soft Tecnoril washbasin is available in three versions.
La baignoire Soft en tecnoril est déclinée en trois versions.*

*La particolare forma inclinata della base lavabo, utile negli spazi con particolari esigenze di ingombro, è ripresa nel gioco estetico dei pensili.
The original, angular shape of the washbasin unit, useful for rooms that have special requirements in terms of dimensions, is picked up again in the design of the wall unit doors.
La forme inclinée de l'élément sous-vasque, utile en cas d'exigences particulières d'espace, est reprise par le jeu esthétique des éléments hauts.*







Con gli innumerevoli moduli presenti a listino, è possibile realizzare zone antibagno o cabine armadio, dove le colonne possono essere attrezzate nei modi più diversi, ad esempio con ripiani portascarpe.

The numerous modules available in our price list can be used to furnish access areas to the bathroom or walk-in wardrobes in which full-height units can be accessorised in different ways, e.g. with shoe racks.

Grâce aux nombreux modules présents dans le tarif, il est possible de réaliser une zone vestibule ou un dressing en aménageant les colonnes de plusieurs façons possibles, comme par exemple avec des tablettes range-chaussures.

Ancora più ampia la scelta per le finiture dei piani: il classico piano in ocritec bianco oppure l'innovativa proposta in versione colorata, con applicata la finitura "effetto cemento" che riprende il vano a giorno e le mensole "ad elle" della composizione.

We offer a really wide choice of finishes for our tops: a traditional white Ocritec top or an innovative coloured one with a cement-effect finish that matches the open-fronted compartment and the L-shaped shelves of this layout.

Le choix pour la finition des plans de toilette est encore plus vaste : le classique plan de toilette en ocritec blanc ou bien l'innovante proposition en version colorée sur laquelle on applique la finition aspect « Cimento » reprise par l'élément ouvert et par les étagères en « L » de la composition.





beauty
will make us
blossom again.

Giancarlo Giannini



La bellezza ci farà fiorire di nuovo. Giancarlo Giannini
Beauty will make us blossom again. Giancarlo Giannini
La beauté nous fera de nouveau prospérer. Giancarlo Giannini

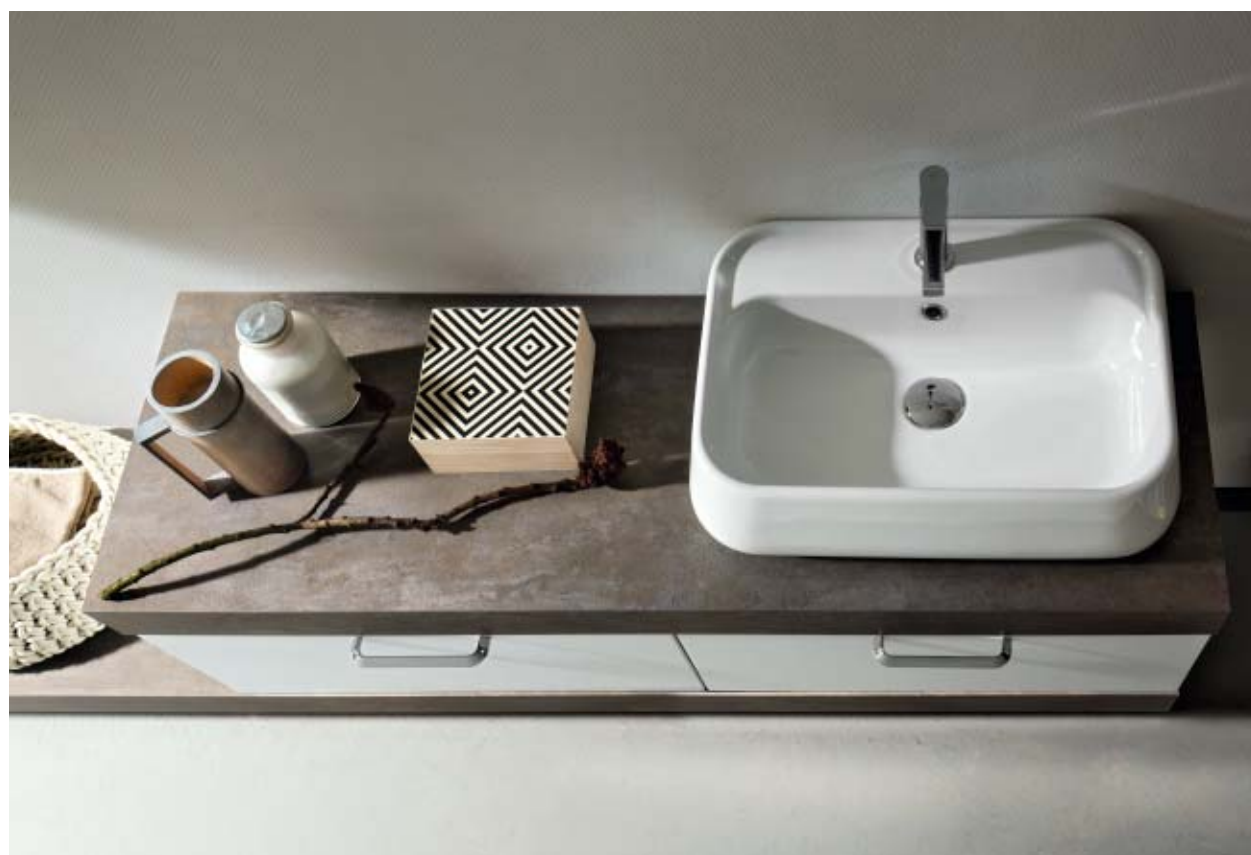

Sul mensolone in finitura oxyde dark possiamo vedere il nuovo lavabo in appoggio Klee.

The new standing Klee washbasin stands out from the Oxyde Dark finish top.

Sur le plan de toilette épais finition Oxyde dark, on peut observer la nouvelle vasque à poser Klee.

Cerasa offre un'ampia scelta di lavabi in appoggio, con miscelatore sulla ceramica oppure sul piano.

Cerasa offers a wide range of standing washbasins with mixer taps installed on the basin or on the top.

Cerasa offre un vaste choix de vasques à poser, avec possibilité d'installer le mitigeur sur plage ou sur plan.

Per i mensoloni in ocrítec, si possono scegliere innumerevoli tipologie di vasche oltre che quattro colori: bianco, tortora, fog e vaniglia.

Numerous types of washbasins, and four colours, are available for the Ocrítec tops: bianco, tortora, fog and vaniglia.

Pour les plans de toilette épais H.6 ou H.10 cm en ocrítec, on pourra choisir d'innombrables modèles de vasques et quatre coloris au choix : blanc, Tortora, Fog et Vaniglia.







*In soli 120 cm è possibile inserire una situazione a doppio lavabo, utilizzando la consolle in ceramica Global con doppia vasca oppure il lavabo in marmoresina Tide, che con il suo ampio bacino consente di alloggiare uno o due miscelatori.
By using the Global ceramic console basin with a double bowl or the Tide basin in engineered marble, whose large bowls can accommodate one or two mixer taps, it is possible to offer two washing spaces in just 120 cm.
Dans 120 cm de large seulement, il est possible d'installer une double vasque en utilisant le plan double vasque Global en céramique ou bien la vasque Tide en marbre de synthèse qui, grâce à son large bassin, permet de loger un ou deux mitigeurs.*





beauty is
the symbol of
morality.

Immanuel Kant

*Il bello è il simbolo del bene morale. Immanuel Kant
Beauty is the symbol of morality. Immanuel Kant
Le beau est le symbole du bien moral. Immanuel Kant*





*Innovativo e funzionale lo specchio a parete con snodi girevoli, può essere collocato sopra ad un lavabo o in qualsiasi altro contesto.
The wall-hung, swivel mirror is both innovative and practical and can be installed above a washbasin or in any other place of your choice.
Innovant et fonctionnel, le miroir mural pivotant peut s'installer soit au-dessus d'une vasque soit dans un autre endroit de l'habitation.*



*Il lavabo d'appoggio in ceramica Prince è disponibile nei colori opachi bianco, marrone, antracite e avio.
The standing, ceramic Prince washbasin is available in matt white, brown, anthracite and avio.
La vasque à poser Prince en céramique est disponible dans les coloris mats Bianco, Marrone, Antracite et Avio.*

*Lo sgabello multiuso è disponibile con il piano in qualsiasi finitura presente a listino e in cinque varianti di colore per la struttura.
The multi-purpose stool can have a top in any of our price list finishes while its frame is available in five colour options.
Le piètement du tabouret multi-usages est décliné en cinq coloris alors que l'assise peut être réalisée dans n'importe quelle finition présente dans le tarif.*

*Le basi lavabo sono sempre fornite con sifone salvaspazio ed ai ripiani interni, in cristallo temperato, viene applicata una spondina contro la caduta degli oggetti.
The washbasin units are always supplied with a space-saver trap while the tempered glass interior shelves are fitted with side guards to prevent things from falling off them.
Les éléments sous-vasque sont toujours fournis avec un siphon gain de place alors que les tablettes intérieures en verre trempé ont un dossier à l'arrière pour empêcher les objets de tomber.*







*Il tavolino in lamiera è disponibile in tutti i colori a campione opachi.
The sheet metal side table is available in all our matt palette colours.
La table d'appoint en tôle existe dans tous les coloris mats de l'échantillonnage.*

*Con la base lavabo curva, disponibile in larghezza 95 e 120 cm, si possono utilizzare i piani integrati Onda oppure i piani in marmo con lavabi sottopiano.
Onda tops with integrated basins or marble tops with under counter basins can be used with 95 and 120 cm wide curved washbasin units.
Avec l'élément sous-vasque arrondi, disponible en largeur 95 et 120 cm, on pourra utiliser le plan-vasque Onda ou bien un plan en marbre avec vasque sous plan.*





La bacinella del piano in cristallo, riprende la forma "a goccia" della base lavabo.
The basin of the glass top picks up the tear-drop shape of the washbasin unit.
La vasque intégrée dans le plan de toilette en verre reprend la forme « goutte » de l'élément sous-vasque.

Lo specchio può essere arricchito dall'elemento con vani passanti a giorno, anch'essi a specchio.
Mirrors can be extended to include open units that are also fitted with mirrors.
Le miroir peut être enrichi de l'élément avec des niches auxquelles on peut accéder de part et d'autre et qui sont masquées par une façade elle aussi miroir.

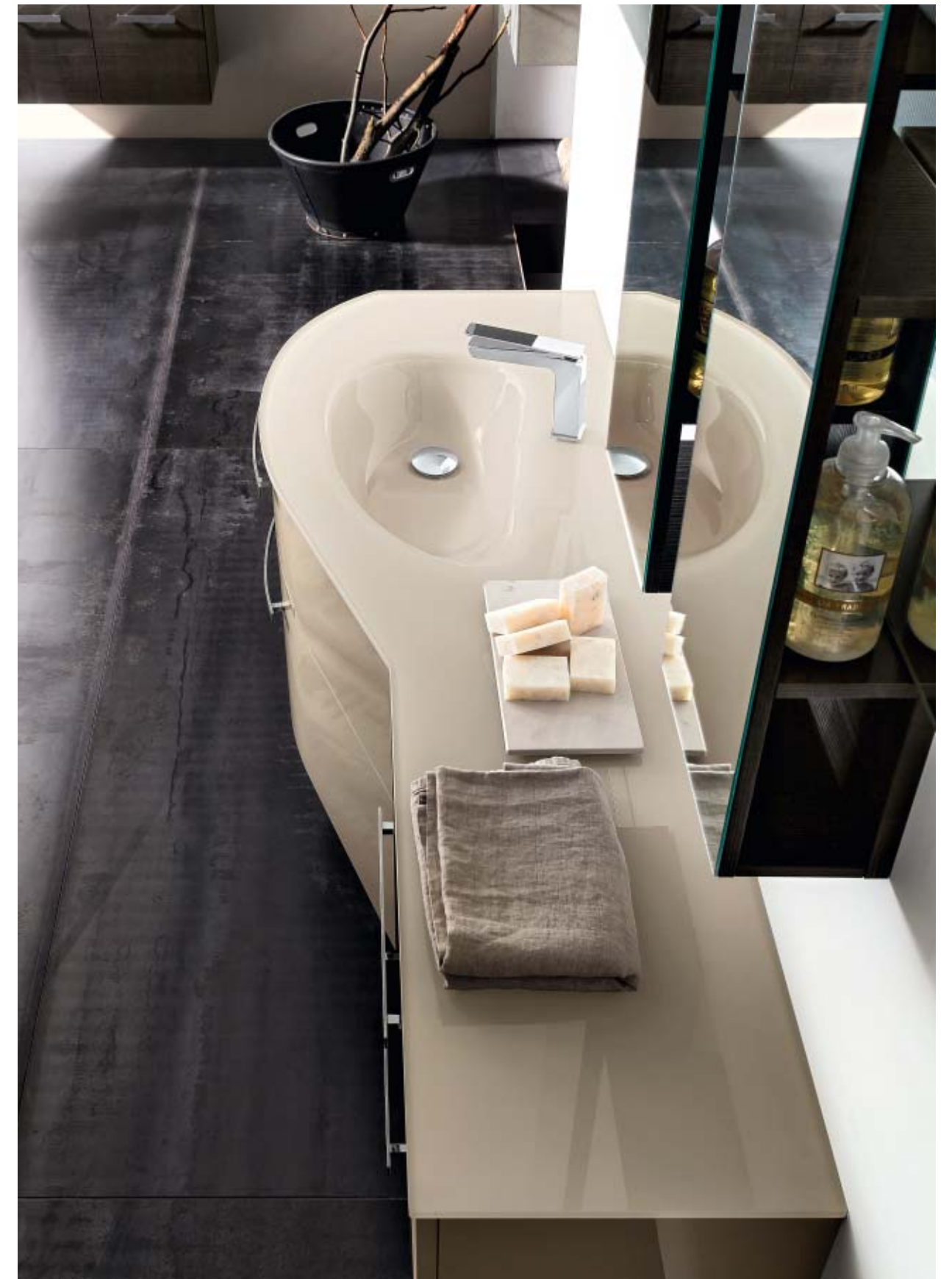





*La base lavabo curva da 70 cm, è disponibile sia nella profondità ridotta di 45.5 cm sia in quella tradizionale di 54 cm.
The 70 cm curved base unit is available in the shallow, 45.5 cm version and in the traditional, 54 cm deep one.
L'élément sous-vasque arrondi de 70 cm peut avoir soit la profondeur réduite de 45,5 cm soit la profondeur traditionnelle de 54 cm.*

*La lampada a led segue il particolare profilo curvo dello specchio.
The led lighting follows the original curved shape of the mirror.
Le spot à leds suit la forme arrondie et particulière du miroir.*





grant
that I may be
beautiful inside.

Socrates

Fate ch'io possa esser bello nel profondo della mia anima. Socrate
Grant that I may be beautiful inside. Socrates
Faites que je puisse être beau au fond de mon âme. Socrate





*Le luci con cui si può accessoriare il cestone, si accendono automaticamente con l'apertura del cassetto.
The lights available for large drawers turn on automatically when the drawer is opened.
L'éclairage avec lequel il est possible d'équiper le coulissant s'allume automatiquement quand on ouvre ce dernier.*



I tradizionali pensili possono essere richiesti anche in versione a specchio.

Traditional wall units can also be requested in the mirror version.

Les traditionnels éléments hauts peuvent également être fournis avec façades miroir.

La cassettera su ruote è rifinita su tutti i lati per essere collocata in qualsiasi situazione.

The mobile drawer unit is finished on all sides, making it perfect in any context.

Le meuble à tiroirs sur roulettes a les quatre côtés finis afin de pouvoir l'installer n'importe où.



I piatti doccia in plus+ton, sono disponibili in diverse varianti di misura e colore.

The Plus+Ton shower trays are available in various sizes and colours.

Les bacs à douche en plus+ton sont réalisés en différentes dimensions et en différents coloris.





*La consolle in ceramica Concept, viene utilizzata per le basi lavabo con profondità 46 cm.
The ceramic Concept console basin is used on 46 cm deep washbasin units.
Le plan-vasque en céramique Concept est utilisé sur les éléments sous-vasque de 46 cm de profondeur.*







*La maniglia Man023 puo' essere laccata a richiesta in qualsiasi colore opaco.
On request, the Man023 handle can be lacquered in any matt colour.
La poignée Man023 peut être laquée, à la demande, dans n'importe quel coloris mat.*

*La consolle Genius viene utilizzata sulle basi lavabo con profondità ridotta di 36 cm; ha un ampio bacino ed una sporgenza totale di 40 cm.
The Genius console basin is used on shallow, 36 cm deep washbasin units. It has a large bowl and protrudes by a total of 40 cm from the wall.
Le plan-vasque Genius est utilisé sur les éléments sous-vasque ayant une profondeur de 36 cm. Il a un large bassin et une profondeur totale de 40 cm.*





*Il lavabo Genius da 120 cm ha la vasca decentrata, destra o sinistra a seconda delle necessità.
The 120 cm Genius basin has an offset bowl that is available on the right or left hand side, as required.
Le plan-vasque Genius de 120 cm a la vasque décentrée à droite, ou à gauche, selon les besoins.*

*Lo specchio tondo su pannello, con luce a led, è disponibile in tutte le finiture presenti a catalogo.
The round mirror with back panel and led lighting is available in all the catalogue finishes.
Le miroir rond sur panneau, avec éclairage à leds, existe dans toutes les finitions présentes dans le catalogue.*



*Nuova la boiserie con schiena in pannello, in tutte le finiture presenti a catalogo, ed elementi a giorno in telaio metallico utilizzabili come mensola o come portasciugamani.
The new wall panelling is available in all the catalogue finishes and with open elements with metal frames that can be used as shelves or as towel rails.
Nouveau panneau mural décliné dans toutes les finitions présentes dans le catalogue et éléments ouverts avec structure métallique utilisables comme étagère ou comme porte-serviettes.*

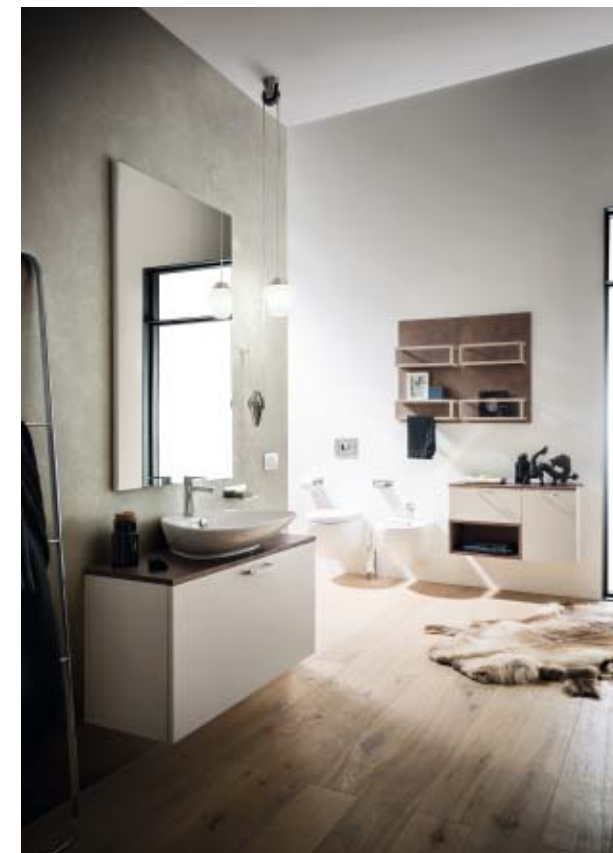



*In mancanza di spazio a parete, è possibile accessoriare i fianchi del mobile con il portasciugamani.
If there is no room on the wall, the towel rails can be attached to the furniture side panels.
À défaut de pouvoir fixer le porte-serviettes au mur par manque de place, on pourra le fixer sur le côté du meuble.*

*Lo specchio contenitivo ad ante versione plus, è corredato di uno specchio ingranditore a ventosa.
The plus version of the mirror cabinet with doors is provided with a magnifying mirror with suction cup.
L'armoire de toilette à portes battantes version plus est dotée d'un miroir grossissant avec ventouse.*

*La sacca portabiancheria è asportabile e lavabile.
The laundry bag can be removed and washed.
Le sac à linge intérieur est amovible et lavable.*





**beauty is
the *splendor*
of truth.**

Platone

La bellezza ci farà fiorire di nuovo. Giancarlo Giannini
Beauty will make us blossom again. Giancarlo Giannini
La beauté nous fera de nouveau prospérer. Giancarlo Giannini





La barra a parete può essere attrezzata con molteplici accessori; disponibile in tutti i colori opachi, prevede una luce di cortesia sul fondo e la presa con interruttore può essere posizionata dove si preferisce.
The wall bar can be fitted with lots of accessories. It is available in all matt colours and has a courtesy light on the bottom edge and a socket with switch wherever desired.
La barre murale peut être équipée de multiples accessoires. Déclinée dans tous les coloris mats, elle prévoit un éclairage d'appoint dans le bas alors que la prise avec interrupteur peut être installée à l'endroit souhaité.

Oltre alla tradizionale colonna lavatrice, è presente a catalogo anche la versione porta lavatrice ed asciugatrice.
As well as the traditional washing machine unit, our catalogue also features a full-height washing machine and dryer unit.
Outre le traditionnel meuble pour lave-linge, il existe également dans le catalogue la colonne pour lave-linge et sèche-linge.

Il lavabo Martin, disponibile in tre varianti di colore, può essere utilizzato non solo sulle strutture in metallo ma anche su basi lavabo normali.
The Martin laundry basin is available in three colour options and can be installed on metal structures or on normal washbasin units alike.
La vasque à poser Martin, disponible en trois coloris, peut non seulement s'installer sur un piètement métallique, mais également sur un élément sous-vasque traditionnel.





*Due le tipologie di lavatoi in ocritec: per basi lavabo da 60 o 70 cm di larghezza, sia in versione lineare che inclinata.
Two types of Ocritec laundry basins are available: for 60 or 70 cm wide washbasin units, in the straight and angular versions.
Il existe deux types de bac à laver en ocritec : pour éléments sous-vasque de 60 ou de 70 cm de large, en version droite ou inclinée.*





**the beauty of
things exists in the
mind of the beholder.**

David Hume



La bellezza delle cose esiste nella mente di chi le contempla. David Hume
The beauty of things exists in the mind of the beholder. David Hume
La beauté des choses existe dans l'esprit de celui qui les contemple. David Hume

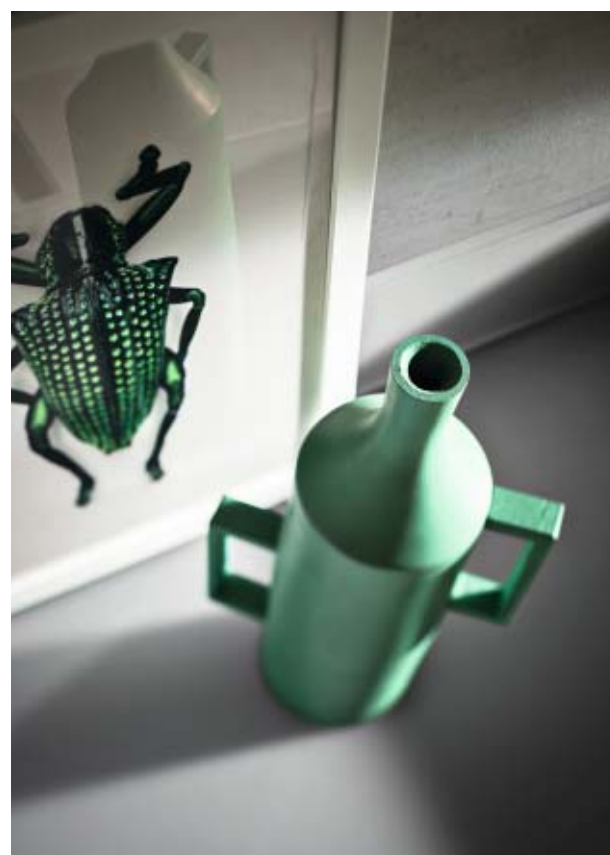

La nuova lampada da specchio su disegno esclusivo Cerasa, può essere posizionata lateralmente o sul lato superiore dello specchio ed è disponibile in cinque varianti di colore.

The new mirror light designed exclusively by Cerasa can be positioned at the side or top of the mirror and is available in five colour options.

Le nouveau spot sur dessin exclusif Cerasa peut s'installer soit sur le côté soit en haut du miroir et existe en cinq coloris.

I pensili possono essere attrezzati con pratici contenitori applicati sull'interno dell'anta.

The inside of wall unit doors can be fitted with practical containers.

Les éléments hauts peuvent être équipés de pratiques boîtes de rangement se fixant à l'intérieur de la porte.







La tavoletta del lavatoio, in posizione orizzontale, riduce visibilmente la profondità della vasca dando la sensazione di un lavabo normale.

Positioned horizontally, the scrubbing board of the laundry basin visibly reduces its depth, giving it the appearance of a normal washbasin.

La planche à laver installée en position horizontale réduit visiblement la profondeur du bac à laver et donne la sensation d'avoir une vasque normale.







Il vano a giorno laterale è estremamente funzionale se posizionato vicino ai sanitari. Tonga e Moala, le serie di accessori esclusivi Cerasa, completano l'offerta d'arredo. Open-fronted side compartments are really practical when installed adjacent to sanitary ware. The exclusive Cerasa Tonga and Moala line of accessories complete our range of furniture. L'élément ouvert latéral est extrêmement fonctionnel s'il est installé près des sanitaires. Les séries d'accessoires Tonga et Moala, exclusivité Cerasa, complètent l'offre.

I piani in cristallo sono disponibili sia lucidi che opachi, ed oltre ai colori di serie è possibile richiedere tinte particolari. Glass tops are available in gloss and matt shades and can be requested in special colours as well as standard ones. Les plans de toilette en verre sont disponibles en version brillante et mate et, outre les coloris standard, il est possible de demander des teintes particulières.

La colonna può essere attrezzata con elementi in lamiera, che la rendono versatile per ogni tipo di utilizzo. Full-height units can be fitted with sheet metal accessories making them perfect for any purpose. La colonna peut être aménagée avec des accessoires en tôle, ce qui la rend adaptée à tout type d'utilisation.







*Lo specchio con struttura in metallo è dotato di una mensola comoda per l'appoggio.
The mirror with a metal structure is provided with a handy shelf.
Le miroir avec structure en métal est doté d'une étagère qui devient un utile plan de dépose.*

*La colonna lavatrice in altezza 120 cm dispone nella parte superiore, di un pratico cesto estraibile.
The 120 cm high washing machine unit has a practical pullout basket at the top.
Le meuble pour lave-linge de 120 cm de haut dispose, dans le haut, d'un pratique panier coulissant.*





L'evoluzione del progetto Play, vuole soddisfare attraverso un'unica collezione estremamente versatile e trasversale, i diversi modi di sentire ed i fabbisogni espressi e riconosciuti nello stile di vita contemporaneo. Il design deve essere fatto di soluzioni studiate in ogni loro dettaglio, l'estetica deve abbracciare la funzionalità ed i materiali devono trasmettere sensazioni forti. La sezione tecnica a seguire, vuole essere una guida all'ottimizzazione e alla personalizzazione dell'offerta.

The goal of Play is to meet the requirements expressed and acknowledged by the various tastes and needs arising from contemporary lifestyles in a single, very versatile and adaptable collection. Design must consist of solutions studied in every detail, aesthetics must include functionality and materials must convey strong emotions. The technical section that follows wants to help users make the most of our furniture and customise it.

L'évolution du projet Play veut satisfaire, à travers une unique collection extrêmement polyvalente et transversale, les différents modes d'être et les besoins actuels du style de vie contemporain. Le design doit avoir des solutions étudiées dans les moindres détails, l'esthétique doit s'unir à la fonctionnalité et les matériaux doivent transmettre des sensations fortes. La section technique qui suit est une orientation à l'optimisation et à la personnalisation de l'offre.

PLAY TECHNICAL INFORMATION	PAGE 262
PLAY MATERIALS	PAGE 252
PLAY ACCESSORIES	PAGE 258
PLAY MODULARITY	PAGE 262

URBAN PLAY PAGE 4

MATERIALS



*essenza old age/ colore metalizzato ghisa Z4 – piano ocritec con vasca integrata colore tortora/ effetto old age
old age wood finish/metallic ghisa Z4 colour – Ocritec/old age effect top with tortora coloured integrated basin
essence Old age/ coloris métallisé Ghisa Z4 – plan de toilette en ocritec avec vasque intégrée coloris Tortora/ aspect Old age*

DIMENSIONS CM. 85 +85 PROF. 46,5

URBAN PLAY PAGE 30

MATERIALS



*rovere graffiato colore opaco ral 7032/ colore metalizzato Z4 – marmoresina bianco lucido – lavabo Anya
matt ral 7032 coloured graffiato oak/ metallic Z4 colour – gloss white engineered marble – Anya washbasin
chêne Graffiato coloris ral 7032 mat/ coloris métallisé Z4 – marbre de synthèse blanc brillant – vasque Anya*

DIMENSIONS CM.233 PROF. 51,5

URBAN PLAY PAGE 12

MATERIALS



*essenza natural/ metalizzato ghisa Z4 – lavabo Martin
natural wood/ metallic ghisa Z4 – Martin laundry tub
essence Natural/ métallisé Ghisa Z4 – vasque Martin*

DIMENSIONS CM. 93 PROF. 46,5 + COLONNA CM. 70 PROF. 36,5

MINIMAL PLAY PAGE 40

MATERIALS



*essenza canapa – piano effetto pietra – lavabi Spencer
canapa wood finish – stone-effect top – Spencer washbasins
essence Canapa – plan de toilette aspect « Pietra » – vasques Spencer*

DIMENSIONS CM. 246 PROF. 46,5/152

URBAN PLAY PAGE 18

MATERIALS



*essenza industrial/ colore opaco ral 3009/ colore ghisa Z4 – piano oxyde rust – lavabo Clipper
industrial wood finish/matt ral 3009 colour/ghisa Z4 colour – oxyde rust top – Clipper washbasin
essence Industrial/ coloris ral 3009/ Ghisa Z4 mat – plan de toilette Oxyde rust – vasque Clipper*

DIMENSIONS CM. 120 (190) PROF. 46,5

MINIMAL PLAY PAGE 46

MATERIALS



*colore opaco ral 3009/ essenza industrial – piano ocritec con vasca integrata tortora/
essenza industrial
matt ral 3009 colour/ industrial wood finish – Ocritec top with integrated tortora basin/
industrial wood finish
coloris ral 3009 mat/ essence Industrial – plan de toilette en ocritec avec vasque intégrée coloris Tortora/ essence Industrial*

DIMENSIONS CM. 265 (315) PROF. 51,5

URBAN PLAY PAGE 24

MATERIALS



*colore bianco opaco/ oxyde dark/ colore ghisa Z4 – lavabo Martin
matt bianco/ oxide dark colour/ ghisa Z4 colour – Martin laundry basin
coloris blanc mat/ Oxyde dark/ coloris Ghisa Z4 – vasque Martin*

DIMENSIONS CM. 180 PROF. 46,5

MINIMAL PLAY PAGE 52

MATERIALS



*rovere graffiato colore opaco ral 7032/ essenza old age – piano tecnoril bianco opaco vasca integrata
matt ral 7032 coloured graffiato oak/old age wood finish – matt white Tecnoril top with integrated basin
chêne Graffiato coloris ral 7032 mat/ essence Old age – plan de toilette en tecnoril blanc mat avec vasque intégrée*

DIMENSIONS CM. 225 PROF. 51,5

MINIMAL PLAY PAGE 56

MATERIALS



*rovere corda – piano con vasca integrata in marmo Maron Marinace
“Corda” oak – Top with integrated basin in marble “Maron Marinace”
chêne “Corda” – Plan de toilette avec vasque moulée en marbre “Maron Marinace”*

DIMENSIONS CM. 194 PROF. 51,5

MINIMAL PLAY PAGE 78

MATERIALS



*laccato opaco in tinta al piano – piano con vasca integrata in ecomalta nebbia
matt colour same as the top – Top with integrated basin in Eco-cement “Nebbia”
couleur mate comme le plan de toilette – Plan de toilette avec vasque moulée en Eco-ciment
“Nebbia”*

DIMENSIONS CM. 170 PROF. 46,5

MINIMAL PLAY PAGE 60

MATERIALS

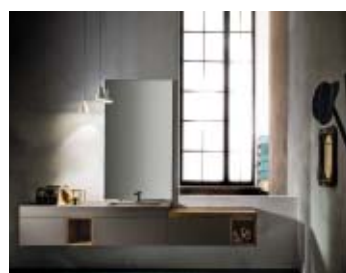

*effetto tavolato/ colore laccato opaco in tinta al piano – mensolone con vasca integrata in
ecomalta fango
“Tavolato” oak and matt colour same as the top – Top h.12 cm with integrated basin in Eco-
cement “Fango”
chêne “Tavolato” et couleur mate comme le plan de toilette – Plan de toilette h.12 cm avec
vasque moulée en Eco-ciment “Fango”*

DIMENSIONS CM. 265 PROF. 51,5

MINIMAL PLAY PAGE 84

MATERIALS



*colore lucido ral 5020/ bianco – piano in marmoresina bianco lucido – lavabo Smart
glossy colour Ral 5020 and glossy “Bianco” (bnl) – Top in Hard-resin glossy “Bianco” –
Basin “Smart”
couleur brillante Ral 5020 et “Bianco” brillant (bnl) – Plan de toilette en Marbre de
synthèse “Bianco” brillant – Vasque “Smart”*

DIMENSIONS CM. 174 PROF. 46,5

MINIMAL PLAY PAGE 68

MATERIALS



*laccato bianco opaco – piano in marmoresina bianco opaco /effetto rovere tavolato –
lavabo Klass
matt “Bianco” (bno) – Top in Hard-resin matt “Bianco” and top h.6 cm in “Tavolato” oak –
Basin “Klass”
“Bianco” mat (bno) – Plan de toilette en Marbre de synthèse “Bianco” mat et plan de toilette
h.6 cm en chêne “Tavolato” – Vasque “Klass”*

DIMENSIONS CM. 167X51,5 – 195X36,5

MINIMAL PLAY PAGE 90

MATERIALS



*colore lucido grigio in tinta al piano – piano in cristallo grigio VT25 – lavabo Tondo
glossy colour same as the top - Top in glass VT25 – Basin “Tondo”
couleur brillante comme le plan de toilette - Plan de toilette en verre VT25 – Vasque
“Tondo”*

DIMENSIONS CM. 70+70 PROF. 51,5

MINIMAL PLAY PAGE 72

MATERIALS



*laccato opaco ral 7035 – mensolone effetto cemento – lavabo Tondo
matt colour Ral 7035 – Top h.6 cm in “Cemento” effect – Basin “Tondo”
couleur mate Ral 7035 – Plan de toilette h.6 cm en effet “Cemento” – Vasque “Tondo”*

DIMENSIONS CM. 275 PROF. 51,5

DECOR PLAY PAGE 94

MATERIALS



*colore lucido ral 3005 – piano in tecnoril bianco opaco vasche integrate
gloss ral 3005 colour – matt white Tecnoril top with integrated washbasins
coloris ral 3005 brillant – tecnoril blanc mat avec vasques intégrées*

DIMENSIONS CM. 175 PROF. 51,5 + COLONNA CM. 50 PROF. 36,5

DECOR PLAY PAGE 102

MATERIALS



*colore lucido bianco – piano in marmo Lillak – lavabo Anya
glossy “Bianco” (bnl) – Top in marble “Lillak” – Basin “Anya”
“Bianco” brillant (bnl) – Plan de toilette en marbre “Lillak” – Vasque “Anya”*

DIMENSIONS CM. 190 PROF. 51,5

CITY PLAY PAGE 122

MATERIALS



*effetto tavolato/ colore opaco tortora BO4 – piano effetto tavolato – lavabo Chelsea
Tavolato effect/matt tortora B04 colour – Tavolato effect top – Chelsea washbasin
aspect « Tavolato »/ coloris Tortora BO4 mat – plan aspect « Tavolato » – vasque Chelsea*

DIMENSIONS CM. 93 PROF. 46,5 + BASI E PENSILI CM. 143 PROF. 36,5

DECOR PLAY PAGE 106

MATERIALS



*colore lucido ral 1001 – piano con vasca integrata in marmo Emperador Dark
glossy colour Ral 1001 – Top with integrated basin in marble “Emperador Dark”
couleur brillante Ral 1001 – Plan de toilette avec vasque moulée en marbre “Emperador
Dark”*

DIMENSIONS CM. 200 PROF. 51,5

CITY PLAY PAGE 126

MATERIALS



*colore opaco grigio scuro GO5/ essenza industrial – mensolone in deimos-stone con vasca
integrata grigio medio
matt grigio scuro GO5 colour/ industrial wood finish – Deimos-stone top with an integrated
basin in grigio medio
coloris grigio scuro GO5 mat/ essenza Industrial – plan de toilette H. 10 cm avec vasque
intégrée en deimos-stone grigio medio*

DIMENSIONS CM. 145 PROF. 51,5

DECOR PLAY PAGE 112

MATERIALS



*colore lucido nero – piano in marmo Nero Marquinia – lavabo Harita
glossy colour NL1 (Ral 9005) – Top in marble “Nero Marquinia” – Basin “Harita”
couleur brillante NL1 (Ral 9005) – Plan de toilette en marbre “Nero Marquinia” – Vasque
“Harita”*

DIMENSIONS CM. 130 PROF. 51,5

CITY PLAY PAGE 132

MATERIALS



*colore lucido ral 7006/ essenza old age – piano ecomalta colore talco vasca integrata
gloss ral 7006 colour/old age wood finish – talco coloured Ecomalta top with integrated
basin
coloris ral 7006 brillant/ essence Old age – plan de toilette en ecomalta coloris Talco avec
vasque intégrée*

DIMENSIONS CM. 165 PROF. 46,5 + COLONNE CM. 70 PROF. 22

DECOR PLAY PAGE 116

MATERIALS



*colore opaco ral 1013 – piano in marmoresina bianco lucido – lavabo Heritage
matt colour Ral 1013 – Top in Hard-resin glossy “Bianco” – Basin “Heritage”
couleur mate Ral 1013 – Plan de toilette Marbre de synthèse “Bianco” brillant – Vasque
“Heritage”*

DIMENSIONS CM. 190 PROF. 46,5

CITY PLAY PAGE 138

MATERIALS



*essenza industrial/colore opaco ral 6011/ ral 7002 – piano marmoresina bianco opaco
vasca integrata
Industrial wood finish/matt ral 6011/ral 7002 colour- matt white engineered marble top
with integrated basin
essence Industrial/coloris ral 6011/ ral 7002 mat – plan de toilette en marbre de synthèse
blanc mat avec vasque intégrée*

DIMENSIONS CM. 187 PROF. 36,5

CITY PLAY PAGE 142

MATERIALS



*essenza natural/ bianco lucido – piano ocritec bianco lucido vasca integrata
natural wood/ gloss white – gloss white Ocritec top with integrated basin
essence Natural/ blanc brillant – plan de toilette en ocritec blanc brillant avec vasque
intégrée*

DIMENSIONS CM. 154 PROF. 51,5/36,5 + COLONNE CM. 105 PROF. 22

CITY PLAY PAGE 164

MATERIALS



*essenza natural/ colore opaco tortora BO4 – ocritec colore tortora – lavabi Prince
natural wood finish/matt tortora BO4 colour – tortora coloured Ocritec – Prince washbasin
essence Natural/ coloris Tortora BO4 mat – ocritec coloris Tortora – vasques Prince*

DIMENSIONS CM. 210 PROF. 51,5

CITY PLAY PAGE 146

MATERIALS



*colore opaco ral 7039/ effetto cemento – piano ocritec con vasca integrata colore fog/ effetto
cemento
matt ral 7039 colour/cement effect – Ocritec/cement effect top with fog coloured integrated
basin
coloris ral 7039 mat/ aspect « Cimento » – plan de toilette en ocritec avec vasque intégrée
coloris Fog/ aspect « Cimento »*

DIMENSIONS CM. 180 PROF. 51,5 + ARMADIATURA CM. 190 PROF. 36,5

CITY PLAY PAGE 170

MATERIALS



*essenza papiro – lavabi Onda
papiro wood finish – Onda washbasins
essence Papiro – vasques Onda*

DIMENSIONS CM. 95+95 PROF. 54/36

CITY PLAY PAGE 150

MATERIALS



*colore opaco bianco/ oxyde dark – lavabo Klee
matt bianco/oxyde dark colour – Klee washbasin
coloris blanc mat/ Oxyde dark – vasque Klee*

DIMENSIONS CM. 210 PROF. 46,5 + BASI CM. 160 PROF. 36,5/22,5

CITY PLAY PAGE 174

MATERIALS



*colore lucido tortora BL4/ rovere cacao – piano cristallo colore tortora lucido vasca
integrata
gloss tortora BL4/ cacao oak colour – gloss tortora coloured glass top with
coloris Tortora BL4 brillant/ chêne cacao – plan de toilette en verre coloris Tortora
brillant avec vasque intégrée integrated basin*

DIMENSIONS CM. 165 PROF. 54,5/36,5 + COLONNE CM. 70 PROF. 36,5

CITY PLAY PAGE 156

MATERIALS



*poro aperto colore opaco ral 6013/ essenza canapa – lavabo Tide
matt ral 6013 coloured open-pore finish/ canapa wood finish – Tide washbasin
pores ouverts coloris ral 6013 mat/ essence Canapa – vasque Tide*

DIMENSIONS CM. 205 PROF. 51,5

CITY PLAY PAGE 178

MATERIALS



*poro aperto colore opaco ral 5007 – piano marmoresina bianco opaco vasca integrata
matt ral 5007 coloured open-pore finish - matt white engineered marble top with
integrated basin
pores ouverts coloris ral 5007 mat – plan de toilette en marbre de synthèse blanc mat avec
vasque intégrée*

DIMENSIONS CM. 140 PROF. 45,5/22

CITY PLAY PAGE 184

MATERIALS



*rovere graffiato colore opaco ral 9002/ ral 7033 – lavabo Concept
matt ral 9002/ral 7033 coloured graffiato oak – Concept basin
chêne Graffiato coloris ral.9002/ ral 7033 mat – vasque Concept*

DIMENSIONS CM. 180 PROF. 46,5

CITY PLAY PAGE 200

MATERIALS



*rovere graffiato colore opaco pergamon B07/ oxyde rust – lavabo Genius
matt pergamon B07/oxyde rust coloured graffiato oak – Genius washbasin
chêne Graffiato coloris Pergamon B07 mat / Oxyde rust – vasque Genius*

DIMENSIONS CM. 120 PROF. 36,5

CITY PLAY PAGE 188

MATERIALS



*essenza papiro/ bianco opaco – lavabo Global
papiro wood finish/ matt bianco – Global washbasin
essence Canapa/ blanc mat – vasque Global*

DIMENSIONS CM. 85 (195) PROF. 51,5

CITY PLAY PAGE 204

MATERIALS



*colore lucido ral 9002 – lavabo Global
gloss ral.9002 colour – Global basin
coloris ral.9002 brillant – vasque Global*

DIMENSIONS CM. 140 PROF. 51,5

CITY PLAY PAGE 192

MATERIALS



*essenza canapa/ papiro – piano ocritec con vasca integrata colore bianco/essenza canapa
canapa/papiro wood finish – Ocritec/canapa wood finish top with bianco integrated basin
essence Canapa/Papiro – plan de toilette en ocritec avec vasque intégrée coloris blanc/
essence Canapa*

DIMENSIONS CM. 85 PROF. 46,5 + COLONNE CM. 65 PROF. 22

CITY PLAY PAGE 208

MATERIALS



*colore lucido ral 9002/ essenza natural – lavabo King
gloss ral.9002 colour/natural wood finish – King basin
coloris ral.9002 brillant/ essence Natural – vasque King*

DIMENSIONS CM. 41 PROF. 22

CITY PLAY PAGE 196

MATERIALS



*essenza industrial/ colore opaco grigio chiaro GO4 tortora B04 – lavabi Genius
industrial wood/matt grigio chiaro GO4 and tortora B04 – Genius washbasins
essence Industrial/ coloris Grigio chiaro GO4 et Tortora B04 mat – vasques Genius*

DIMENSIONS CM. 70+70 PROF. 36,5 + COLONNE CM. 110 PROF. 36/22

CITY PLAY PAGE 212

MATERIALS



*colore opaco ral 7011/ essenza old age – piano essenza old age – lavabo Fly
matt 7011 colour/ old age wood finish – old age wood finish top – Fly washbasin
coloris ral 7011 mat/ essence Old age – plan de toilette en essence Old age – vasque Fly*

DIMENSIONS CM. 105 (310) PROF. 46,5 + COLONNA CM. 70 PROF. 60

CITY PLAY PAGE 216

MATERIALS



*essenza cacao/colore opaco grigio scuro GO5 – piano ocritec bianco opaco lavatoio integrato
cacao wood finish/matt grigio scuro GO5 colour – white Ocritec top with integrated laundry basin
essence Cacao/coloris Grigio scuro GO5 mat – plan de toilette en ocritec blanc mat avec bac à laver intégré*

DIMENSIONS CM. 180 PROF. 51,5/36,5

CITY PLAY PAGE 234

MATERIALS



*poro aperto ral 3009/ bianco opaco – lavabo Global
open pore Ral 3009/ matt bianco – Global washbasin
pores ouverts ral 3009/ blanc mat – vasque Global*

DIMENSIONS CM. 95 PROF. 51,5

CITY PLAY PAGE 220

MATERIALS



*essenza canapa – piano cristallo satinato cenere – lavabo Icon
canapa wood finish – satin cenere glass top – Icon washbasin
essence Canapa – plan de toilette en verre satiné Cenere – vasque Icon*

DIMENSIONS CM. 210 PROF. 51,5

CITY PLAY PAGE 226

MATERIALS



*essenza cacao/ colore opaco ral 5023 – piano ocritec bianco lucido lavatoio integrato
cacao wood finish/matt ral 5023 colour – gloss white Ocritec top with integrated laundry basin
essence Cacao/ coloris ral 5023 mat – plan de toilette en ocritec blanc brillant avec bac à laver intégré*

DIMENSIONS CM. 145 (170) PROF. 46,5

CITY PLAY PAGE 230

MATERIALS



*essenza corda/ colore opaco ral 7006/ grigio scuro GO5 – piano cristallo colore a campione satinato vasca integrata
corda wood finish/ matt ral 7006 colour/grigio scuro GO5 – satin glass top in our palette colours – integrated basin
essence Corda/ coloris ral 7006/ grigio scuro GO5 mat – plan de toilette en verre satiné coloris sur échantillon avec vasque intégrée*

DIMENSIONS CM. 107 PROF. 51,5

ELEMENTI CON TELAIO METALLICO ELEMENTS WITH METAL FRAMES. ÉLÉMENTS AVEC CADRE MÉTALLIQUE.



BASI LAVABO **COLONNE A GIORNO** **BOISERIE** **SGABELLO** **PORTASCIUGAMANI** **SPECCHIO CON TELAIO**

Washbasin units *Full-height open units* *Wall panelling* *Stool* *Towel rail unit* *Mirror with frame*
Éléments sous-vasque *Colonnes ouvertes* *Panneaux muraux* *Tabouret* *Porte-serviettes* *Miroir avec cadre*

COLORI DISPONIBILI COLOURS AVAILABLE. COLORIS DISPONIBLES.



SPECCHIO MOVIBILE **SPECCHIO OVALE** **BIANCO** **TORTORA** **GRIGIO CHIARO** **GRIGIO SCURO** **GHISA**

Swivel mirror *Oval mirror* *Bianco* *Tòtora* *Grigio chiaro* *Grigio scuro* *Ghisa*
Miroir pivotant *Miroir ovale* *Bianco* *Tòtora* *Grigio chiaro* *Grigio scuro* *Ghisa*

LAVABO MARTIN IN DEIMOS-STONE

COLORI DISPONIBILI COLOURS AVAILABLE. COLORIS DISPONIBLES.



BIANCO SALE **GRIGIO MEDIO** **ECRÙ**

Martin laundry basin in Deimos-Stone
Vasque Martin en deimos-stone

Bianco Sale *Grigio medio* *Ecrù*
Bianco Sale *Grigio medio* *Ecrù*

MATERIALE DISPONIBILE ANCHE PER PIANI TOP E MENSOLONI CON VASCA INTEGRATA THIS MATERIAL IS ALSO AVAILABLE FOR SLIM AND THICK TOPS WITH INTEGRATED BASINS. MATÉRIAU ÉGALEMENT DISPONIBLE POUR LES PLANS DE TOILETTE ET LES PLANS H. 6-10 CM AVEC VASQUE INTÉGRÉE.

LAMPADE ESCLUSIVE EXCLUSIVE LIGHT FIXTURES. LUMINAIRES EXCLUSIFS.



LAMPADA DA TERRA **LAMPADA DA SOFFITTO** **LAMPADA DA SPECCHIO** **LAMPADA A SOSPENSIONE**

Floor-standing lamp *Ceiling light* *Mirror light* *Pendant lamp*
Lampadaire sur pied *Plafonnier* *Spot* *Suspension*

COLORI DISPONIBILI COLOURS AVAILABLE. COLORIS DISPONIBLES.

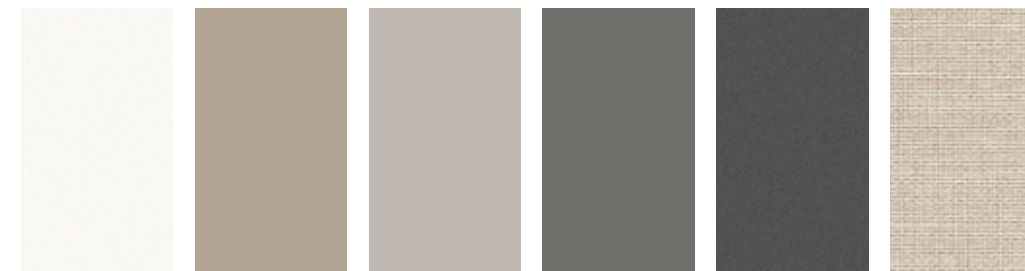

BIANCO **TORTORA** **GRIGIO CHIARO** **GRIGIO SCURO** **GHISA** **TESSUTO**

Bianco *Tòtora* *Grigio chiaro* *Grigio scuro* *Ghisa* *Fabric*
Bianco *Tòtora* *Grigio chiaro* *Grigio scuro* *Ghisa* *Tissu*

LAVABO PRINCE IN CERAMICA OPACA

COLORI DISPONIBILI COLOURS AVAILABLE. COLORIS DISPONIBLES.

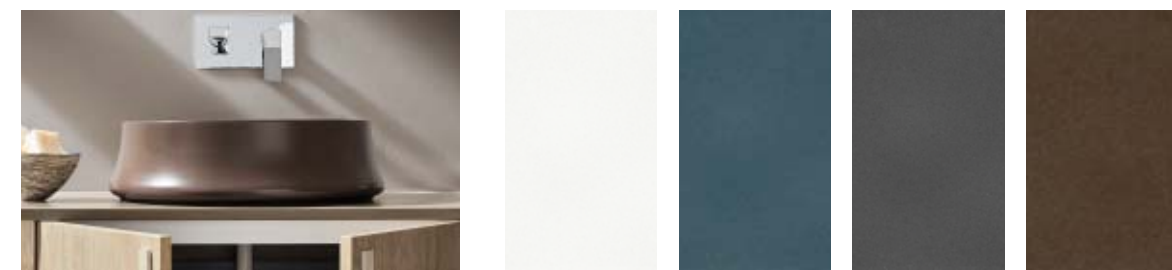

BIANCO **AVIO** **ANTRACITE** **MARRONE**

Matt ceramic prince washbasin
Vasque prince en céramique mate

Bianco *Avio* *Antracite* *Marrone*
Bianco *Avio* *Antracite* *Marrone*

ABBINAMENTI ESSENZE/ OCRITEC COLORATO OPACO WOOD/ MATT COLOURED OCRITEC PAIRINGS. COMBINAISONS ESSENCES/ OCRITEC COLORÉ MAT.



MATERIALS



NATURAL

*Natural
Natural*

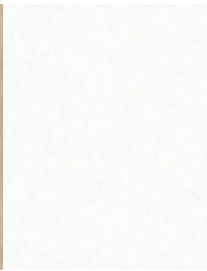

BIANCO OPACO

*Matt Bianco
Blanc mat*

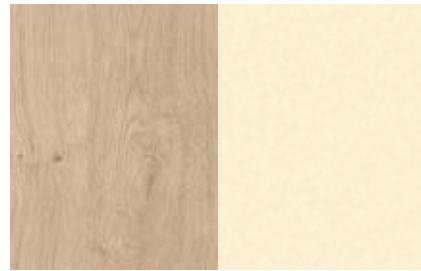

NATURAL

*Natural
Natural*

VANIGLIA OPACO

*Matt Vaniglia
Vaniglia mat*

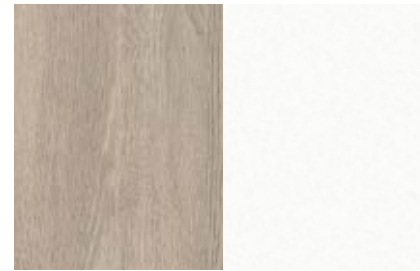

ROVERE CANAPA

*Canapa oak
Chêne « canapa »*

BIANCO OPACO

*Matt Bianco
Blanc mat*



ROVERE CANAPA

*Canapa oak
Chêne « canapa »*

TORTORA OPACO

*Matt Tortora
Tortora mat*



INDUSTRIAL

*Industrial
Industrial*

TORTORA OPACO

*Matt Tortora
Tortora mat*



OLD AGE

*Old Age
Old Age*

BIANCO OPACO

*Matt Bianco
Blanc mat*

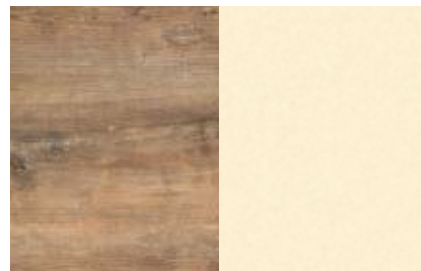

OLD AGE

*Old Age
Old Age*

VANIGLIA OPACO

*Matt Vaniglia
Vaniglia mat*



EFFETTO TAVOLATO

*Tavolato oak effect
Effet chêne tavolato*

TORTORA OPACO

*Matt Tortora
Tortora mat*



EFFETTO CEMENTO

*Cemento effect
Effet cemento*

BIANCO OPACO

*Matt Bianco
Blanc mat*



EFFETTO CEMENTO

*Cemento effect
Effet cemento*

FOG OPACO

*Matt Fog
Fog mat*

FINITURE DISPONIBILI NEI COLORI LACCATI A CAMPIONE FINISHES AVAILABLE FOR OUR PALETTE LACQUER COLOURS. FINITIONS DISPONIBLES DANS LES COLOURS LAQUÉS SUR ÉCHANTILLON.



LISCIO OPACO

*Plain matt
Lisse mat*



LISCIO LUCIDO

*Plain gloss
Lisse brillant*



PORO APERTO OPACO

*Matt open pore
Pores ouverts mat*



GRAFFIATO OPACO

*Matt graffiato
« Graffiato » mat*

ESSENZE WOOD FINISHES. ESSENCES.



ROVERE PAPIRO NATURAL ROVERE CANAPA INDUSTRIAL ROVERE CORDA ROVERE CACAO

Papiro oak
Chêne papiro *Natural*
Natural *Canapa oak*
Chêne canapa *Industrial*
Industrial *Corda oak*
Chêne corda *Cacao oak*
Chêne cacao

FINITURE NATURALI NATURAL FINISHES. FINITIONS NATURELLES.



EFFETTO PIETRA EFFETTO CEMENTO EFFETTO TAVOLATO OLD AGE OXYDE DARK OXYDE RUST

Pietra effect
Effet pietra *Cemento effect*
Effet cemento *Tavolato oak effect*
Effet chêne tavolo *Old Age*
Old Age *Oxyde Dark*
Oxyde Dark *Oxyde Rust*
Oxyde Rust

DISPONIBILI SOLO PER TOP, MENSOLE, MENSOLONI E VANI A GIORNO AVAILABLE FOR SLIM TOPS, SHELVES, THICK TOPS AND OPEN COMPARTMENTS ONLY. DISPONIBLES UNIQUEMENT POUR PLANS ET PLANS H.6/10 CM, ÉTAGÈRES ET ÉLÉMENTS OUVERTS.

FINITURE ECOMALTA PER TOP E MENSOLONI ELEMENTI DA APPOGGIO. ELEMENTI DA APPOGGIO.



NEBBIA FANGO BEIGE ARGILLA SAND TALCO

Nebbia
Nebbia *Fango*
Fango *Beige*
Beige *Argilla*
Argilla *Sand*
Sand *Talco*
Talco

COLORI OCRITEC OCRITEC COLOURS. COLORIS OCRITEC.

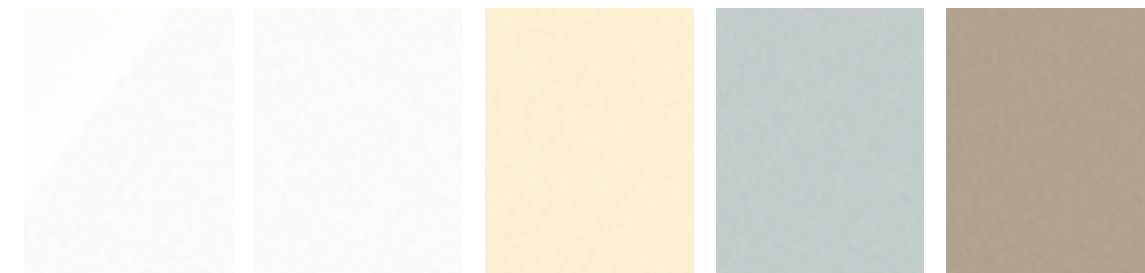

BIANCO LUCIDO BIANCO OPACO VANIGLIA OPACO FOG OPACO TORTORA OPACO

Gloss Bianco
Blanc brillant *Matt Bianco*
Blanc mat *Matt Vaniglia*
Vaniglia mat *Matt Fog*
Fog mat *Matt Tortora*
Tortora mat

PIETRE NATURALI NATURAL STONE. PIERRES NATURELLES.



EMPERADOR DARK MARON MARINACE LILLAK QUARZ WHITE TATUM CLOUDY BEIGE TATUM BRUGHIERA

Emperador Dark
Emperador Dark *Lillak*
Lillak *Maron Marinace*
Maron Marinace *Quarz White*
Quarz White *Tatum Cloudy Beige*
Tatum Cloudy beige *Tatum Brughiera*
Tatum Brughiera



TATUM PORTLAND GREY QUARZ GRIGIO SCURO

Tatum Portland Grey
Tatum Portland Grey *Quarz grigio scuro*
Quarz grigio scuro

DISPONIBILI PER TOP E MENSOLONI CON VASCHE COSTRUIITE AVAILABLE FOR SLIM AND THICK TOPS WITH BUILT-IN BASINS. DISPONIBLES POUR PLANS ET PLANS H.10/ H.6

AVEC VASQUES COLLÉES ET INTÉGRÉES.

ELEMENTI PER FIANCO CASSETTI ELEMENTS TO ATTACH TO DRAWER SIDE PANELS. ACCESSOIRES À FIXER AU CÔTÉ DU TIROIR.



SCATOLA 1 VANO

*Box with 1 compartment
Boîte 1 compartiment*



SCATOLA 2 VANI

*Box with 2 compartments
Boîte 2 compartiments*



PORTA BICCHIERE

*Glas holder
Boîte avec porte-verre*



PORTA KLEENEX

*Tissue box holder
Boîte porte-kleenex*

ELEMENTI DA APPOGGIO STANDING ELEMENTS. ACCESSOIRES À POSER.



PATTUMIERA

*Garbage box
Boîte poubelle*



SCATOLA 1 VANO

*Box with 1 compartment
Boîte 1 compartiment*



SCATOLA 3 VANI

*Box with 3 compartments
Boîte 3 compartiments*



SCATOLA PORTA KLEENEX

*Tissue box holder
Boîte porte-kleenex*



PORTA PHON

*Hair dryer holder
Boîte pour sèche-cheveux*



**SCATOLA 1 VANO GRANDE
CON PORTATRUCCO**

*Box with 1 large compartment
with make up section
Boîte 1 grand compartiment
range-maquillage*



**SCATOLA 1 VANO PICCOLO
CON PORTATRUCCO**

*Box with 1 small compartment
and vanity section
Boîte 1 petit compartiment et
range-maquillage*



**SCATOLA 1 VANO GRANDE
CON PORTATRUCCO**

*Box with 1 large compartment
with make up section
Boîte 1 grand compartiment
range-maquillage*

ELEMENTI DI SERVIZIO MISCELLANEOUS ACCESSORIES. ÉCLAIRAGE ET SÉPARATEURS.



SEPARATORI

*Dividers
Séparateurs*



LUCE INTERNA CASSETTO

*Interior light for drawers
Éclairage intérieur tiroir*



TAPPETINO

*Mat
Tapis fond de tiroir*

ELEMENTI PER INTERNO PENSILI ELEMENTS TO FIT INSIDE DOOR PANELS. ACCESSOIRES POUR INTÉRIEUR PORTES.



LUCE INTERNO PENSILE

*Interior light for wall unit
Éclairage intérieur élément haut*



SCATOLA CON COPERCHIO

*Box with lid
Boîte avec couvercle*



PORTA CALAMITA

*Magnet for accessories
Aimant pour accessoires*



PORTA BICCHIERE

*Glas holder
Porte-verre*

BARRA ATTREZZATA WALL-HUNG ACCESSORY BAR. BARRE MURALE ÉQUIPÉE.



BARRA ATTREZZATA IN ALLUMINIO CON LUCE LED E PRESA INTERRUPTORE, COLORE OPACO A CAMPIONE

*Aluminium wall-hung bar with led light, socket and switch, available in matt colours
Barre équipée en aluminium avec éclairage à leds et prise/interrupteur, coloris mat*



PORTA ASCIUGAMANO CROMATO A MISURA, PER BARRA ATTREZZATA

*Custom-sized, chromed towel holder for wall-hung accessory bar
Porte-serviettes chromé sur mesure, pour barre équipée*

ACCESSORI ACCESSORIES. ACCESSOIRES.



LUCE FONDO MOBILE

*Bottom panel light
Éclairage sous meuble*



ATTREZZATURA IN LAMIERA

*Sheet metal accessories
Accessoires intérieurs en tôle*



PORTA SCARPE

*Shoe rack
Range-chaussures*



SCATOLA CON COPERCHIO PICCOLA

*Small Box with lid
Petite boîte avec couvercle*



SCATOLA CON COPERCHIO GRANDE

*Large Box with lid
Grande boîte avec couvercle*



PORTA BICCHIERE

*Glas holder
Porte-verre*



PORTA SAPONE

*Glas holder
Porte-savon*



CESTO ESTRAIBILE

*Pullout basket
Panier coulissant*



SACCA BIANCHERIA

*Laundry basket
Sac à linge intérieur*



SIFONE SALVASPAZIO

*Space-saver trap
Siphon gain de place*



PORTA PHON

*Hair dryer holder
Porte sèche-cheveux*



PORTA CALAMITA

*Magnet for accessories
Aimant pour accessoires*



SPECCHIO INGRANDITORE

*Magnifying mirror
Miroir grossissant*

BASI DI RACCORDO PER ELEMENTI DIRITTI CONNECTING BASE UNITS FOR STRAIGHT UNITS. ÉLÉMENTS BAS DE LIAISON POUR ÉLÉMENTS DROITS.

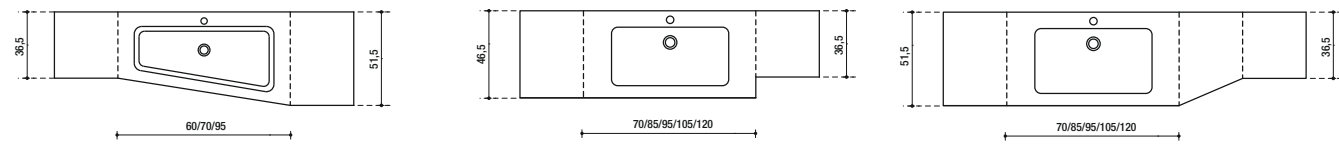

PENSILI INCLINATI INCLINED WALL UNITS. ÉLÉMENTS HAUTS INCLINÉS.

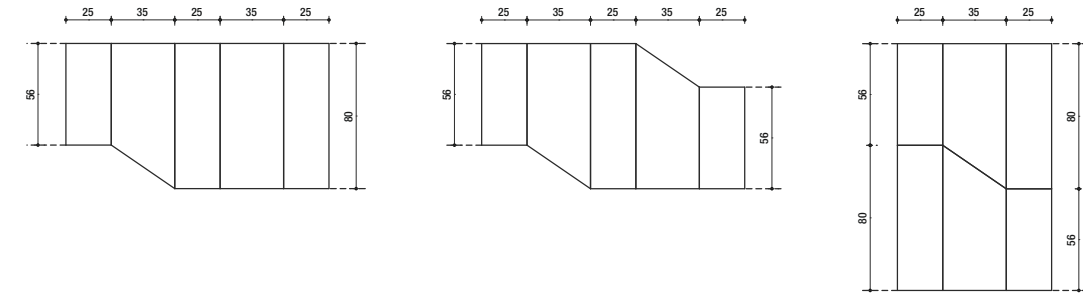

BASI DI RACCORDO PER ELEMENTI CURVI CONNECTING BASE UNITS FOR CURVED UNITS. ÉLÉMENTS BAS DE LIAISON POUR ÉLÉMENTS ARRONDIS.

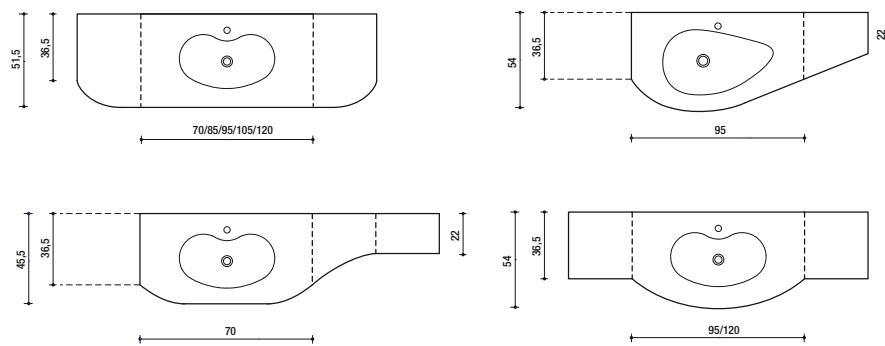

PENSILI IN COLONNA IN-COLUMN WALL UNITS. ÉLÉMENTS HAUTS AGENCÉS EN COLONNE.

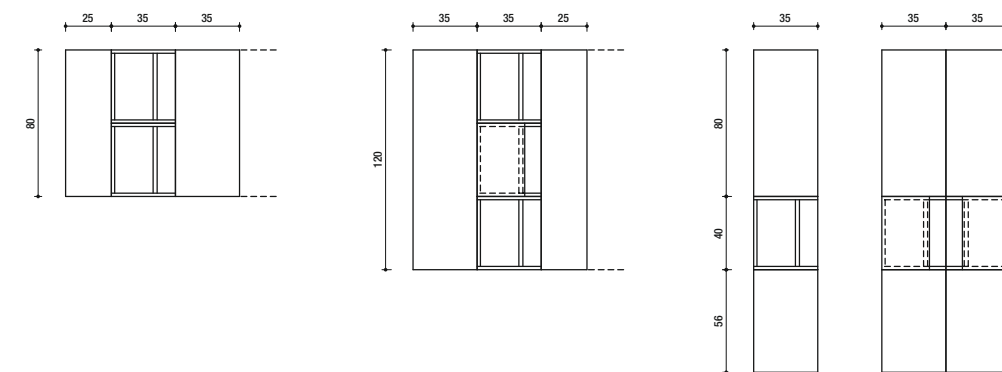

MENSOLONI TOPS H10-H6. PLANS DE TOILETTE H10-H6.

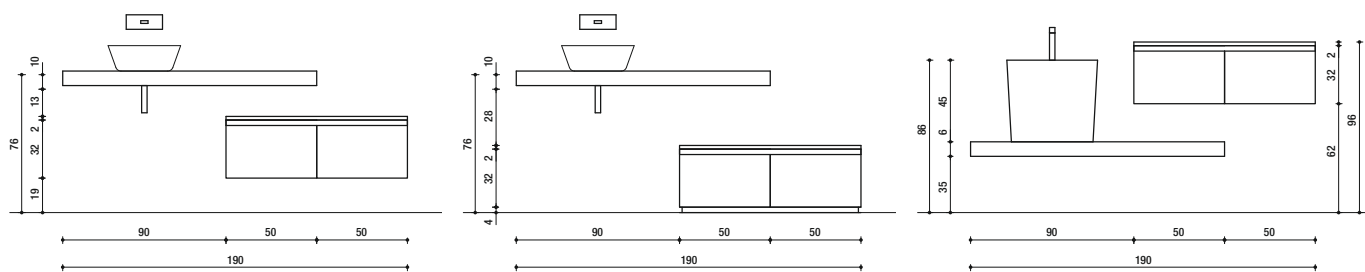

PENSILE PARTICOLARE/ PENSILI LIBERI SPECIAL WALL UNIT. ÉLÉMENT HAUT PARTICULIER./ INDEPENDENT WALL UNITS. ÉLÉMENTS HAUTS INDIVIDUELS.

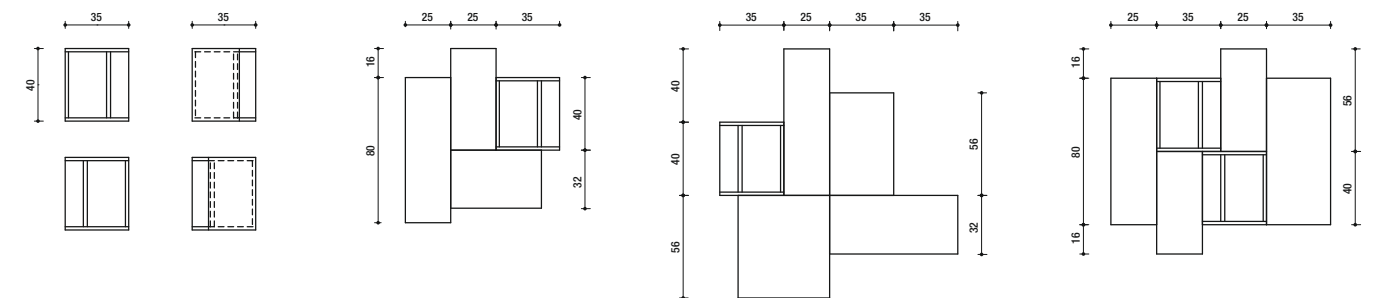

ARMADIATURE A GIORNO OPEN UNITS FOR WARDROBES. SYSTÈME DE RANGEMENT OUVERT.

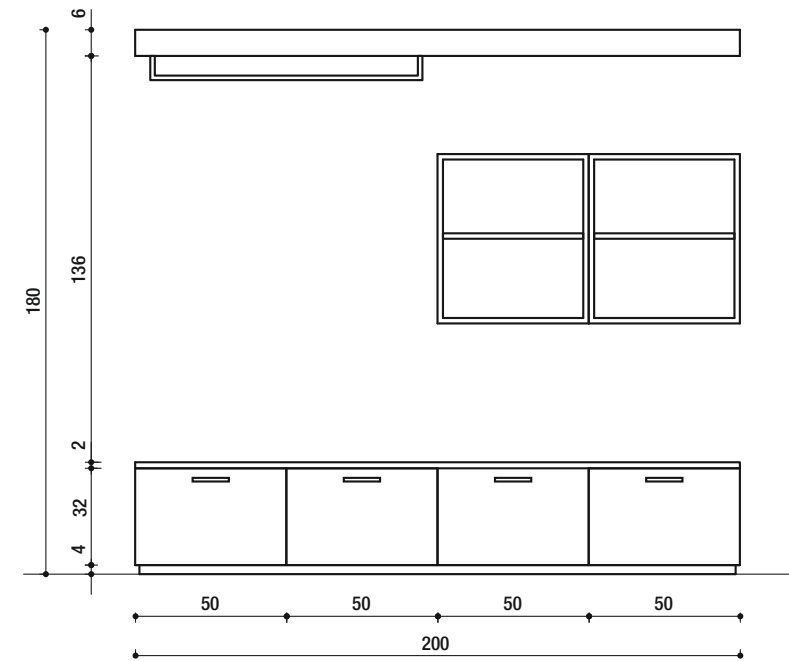
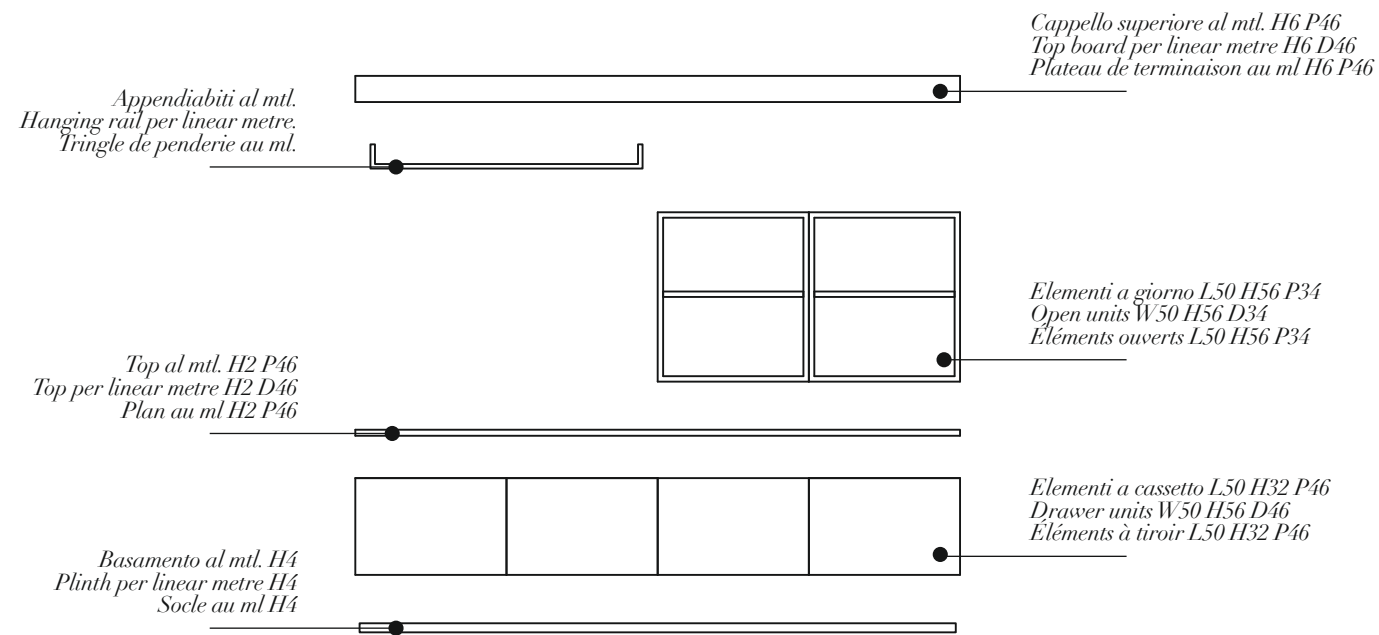

Con gli elementi di Play, è possibile creare anche delle zone arredate con la funzione di cabina armadio.
 Play's units can even be used to create walk-in-wardrobes.
 Les éléments du modèle Play permettent également de créer et d'agencer des dressings.

A lato, esempio di composizione esplosa, realizzata con alcuni degli elementi presenti a listino. Qui, esempio della composizione finita.
 The side view shows a composition created using some of the elements in the price list. Here is an example of the finished composition.
 Vue éclatée d'une composition réalisée avec quelques-uns des éléments présents dans le tarif. Ici, exemple de la composition finie.

MENSOLONI TOPS H10-H6. PLANS DE TOILETTE H10-H6.

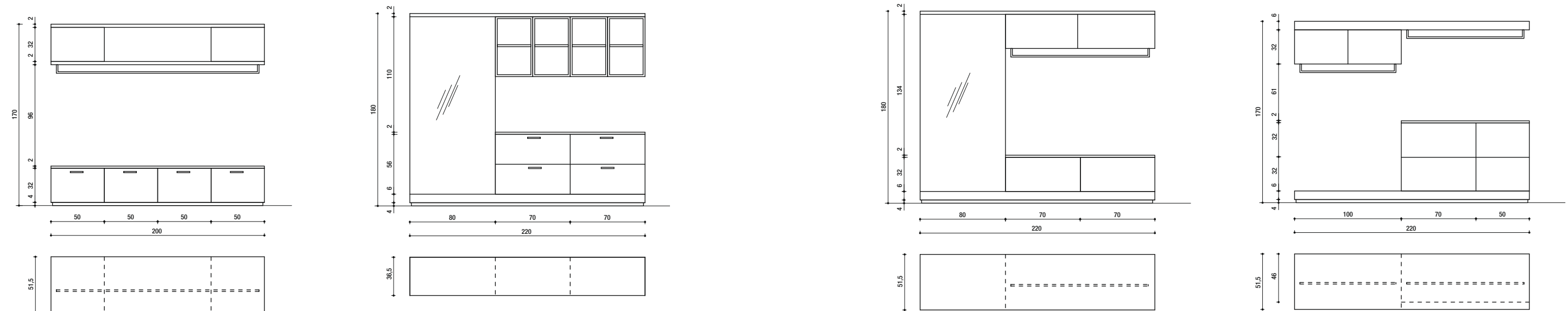

Altri esempi di composizioni finite.
 Other examples of finished compositions.
 D'autres exemples de compositions finies.

LAVABI IN APPOGGIO ALTI TALL STANDING BASINS. VASQUES À POSER HAUTES.

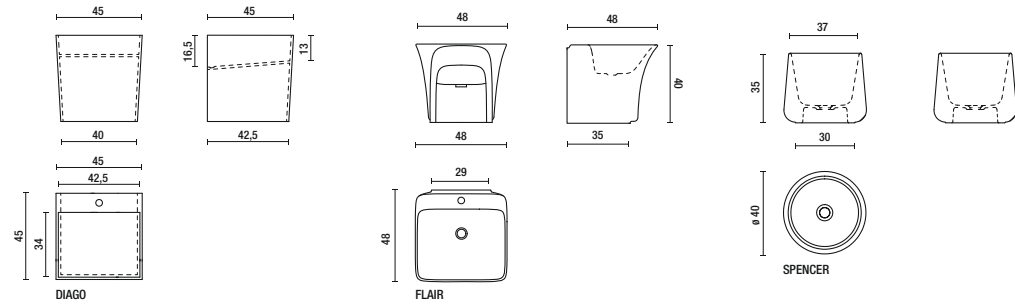

LAVABI IN APPOGGIO STANDING BASINS. VASQUES À POSER.

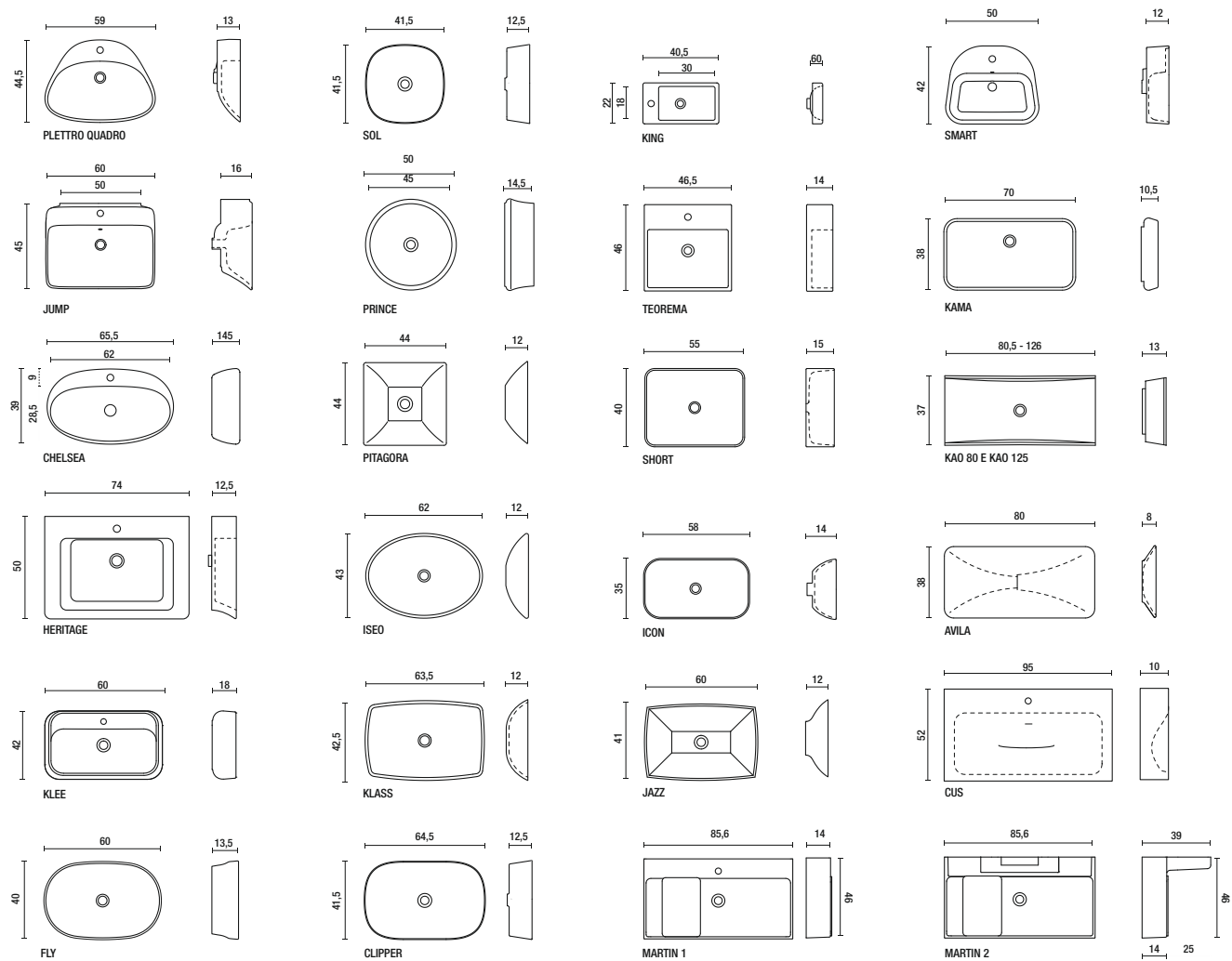

CONSOLE GLOBAL P. 51,5 CM

GLOBAL CONSOLE. PLAN-VASQUE GLOBAL.

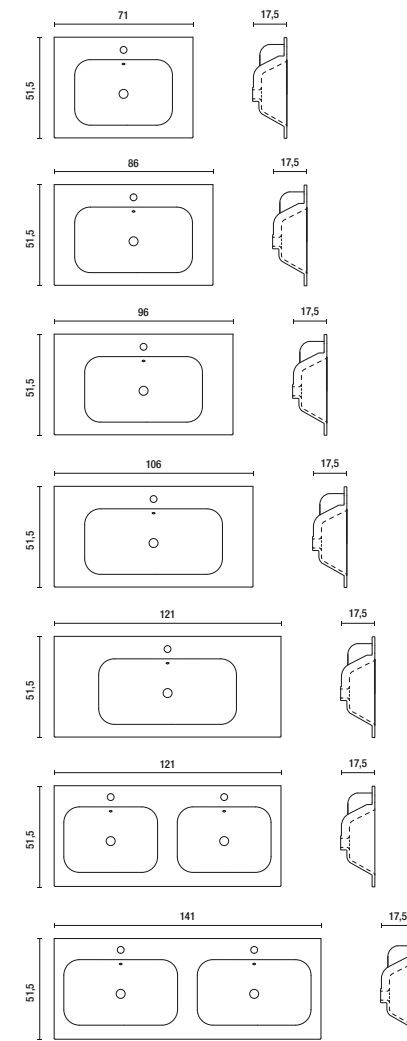

CONSOLE CONCEPT P. 46,5 CM

CONCEPT CONSOLE. PLAN-VASQUE CONCEPT.

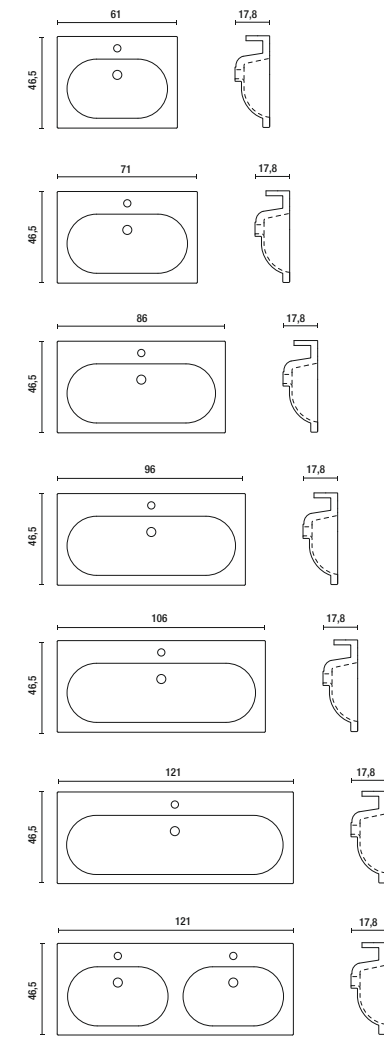

CONSOLE GENIUS P. 40 CM

GENIUS CONSOLE BASIN. PLAN-VASQUE GENIUS.

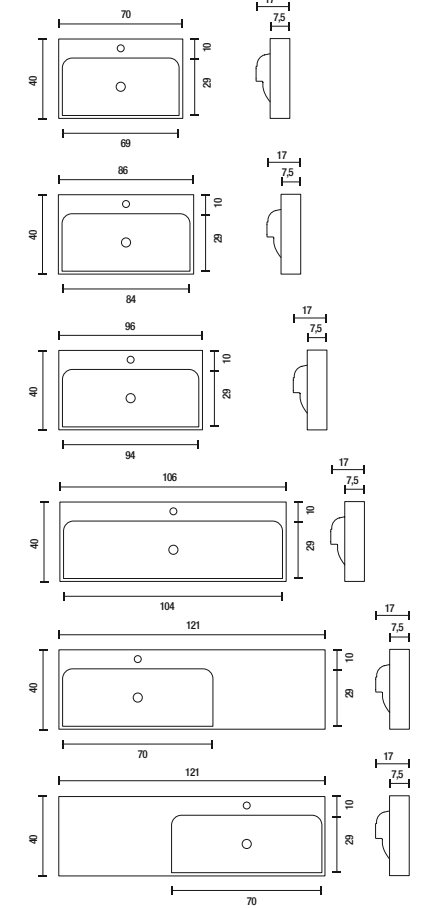

Console in ceramica per realizzare composizioni monoblocco.
Ceramic console for vanity units.
Plan-vasque en céramique pour réaliser des compositions monoblocs.

VASCHE PER PIANI PROF. 36,5 IN TECNORIL E MARMORESINA BASINS FOR 36.5-CM DEEP TECNORIL AND HARD RESIN TOPS. VASQUES POUR PLANS PROF. 36,5 EN TECNORIL ET MARBRE DE SYNTHÈSE.

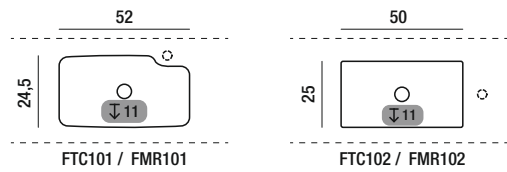

*In base al materiale del piano, sono disponibili innumerevoli forme per la vasca integrata.
Several shapes are available for integrated basins depending on the material of the top.
En fonction du matériau choisi pour le plan de toilette, ils existent de nombreuses formes possibles pour la vasque moulée.*

VASCHE PER PIANI PROF. 51,5 IN TECNORIL BASINS FOR 51.5-CM DEEP TECNORIL TOPS. VASQUES POUR PLANS PROF. 51,5 EN TECNORIL.

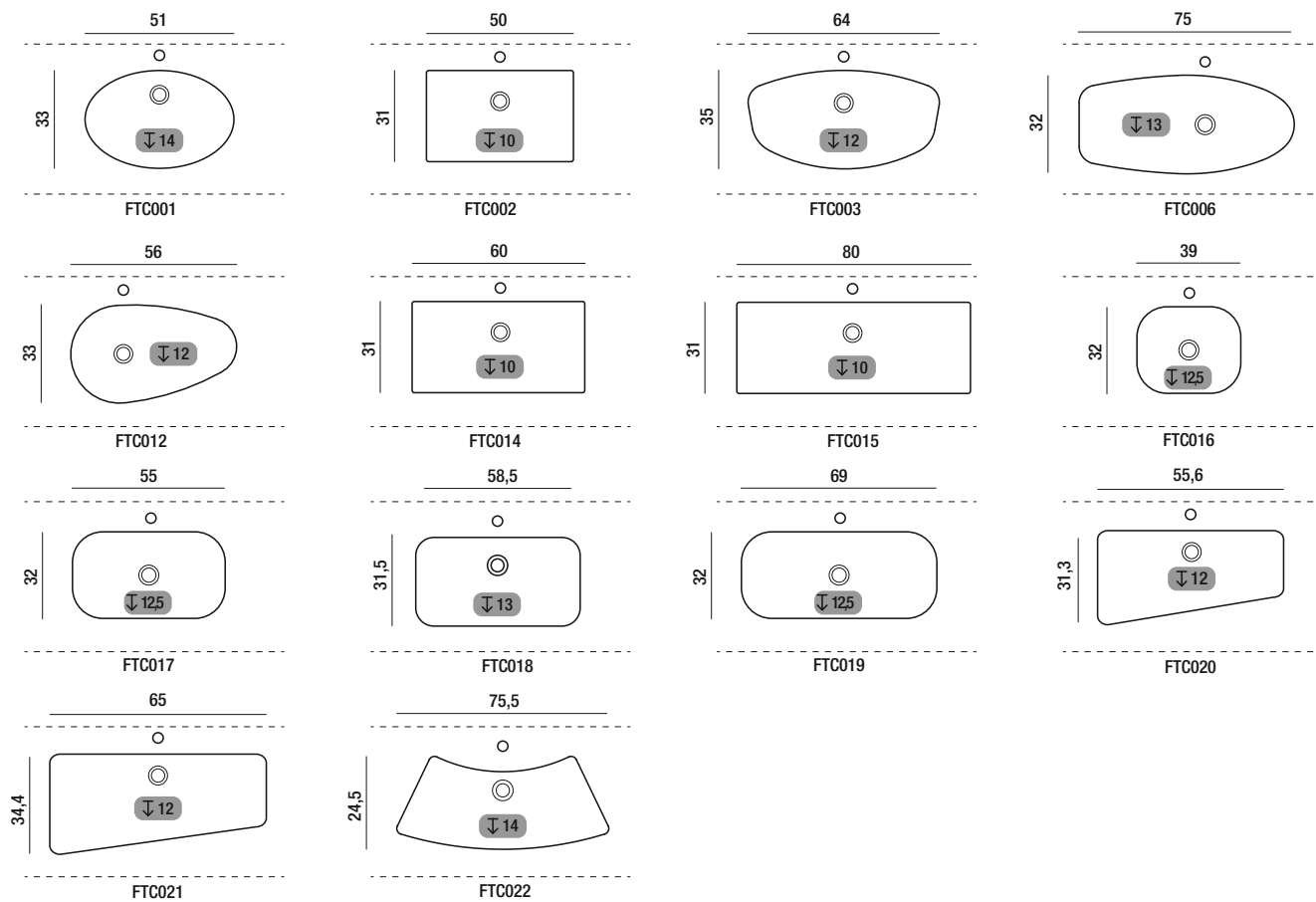

VASCHE PER PIANI PROF. 46 IN TECNORIL E MARMORESINA BASINS FOR 46-CM DEEP TECNORIL AND HARD RESIN TOPS. VASQUES POUR PLANS PROF. 46 EN TECNORIL ET MARBRE DE SYNTHÈSE.

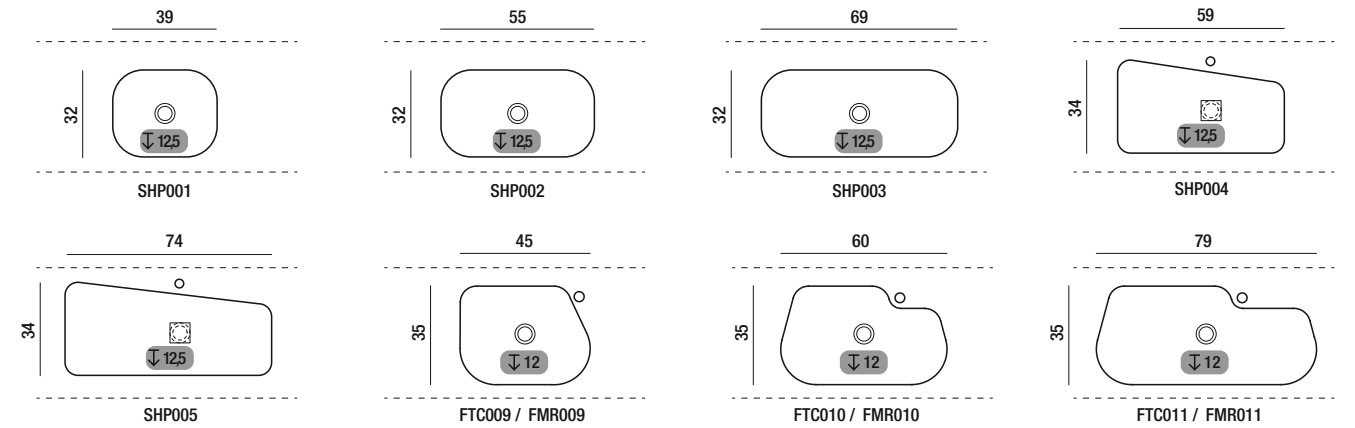

VASCHE PER PIANI PROF. 51,5 IN MARMORESINA BASINS FOR 51.5-CM DEEP HARD RESIN TOPS. VASQUES POUR PLANS PROF. 51,5 EN MARBRE DE SYNTHÈSE.

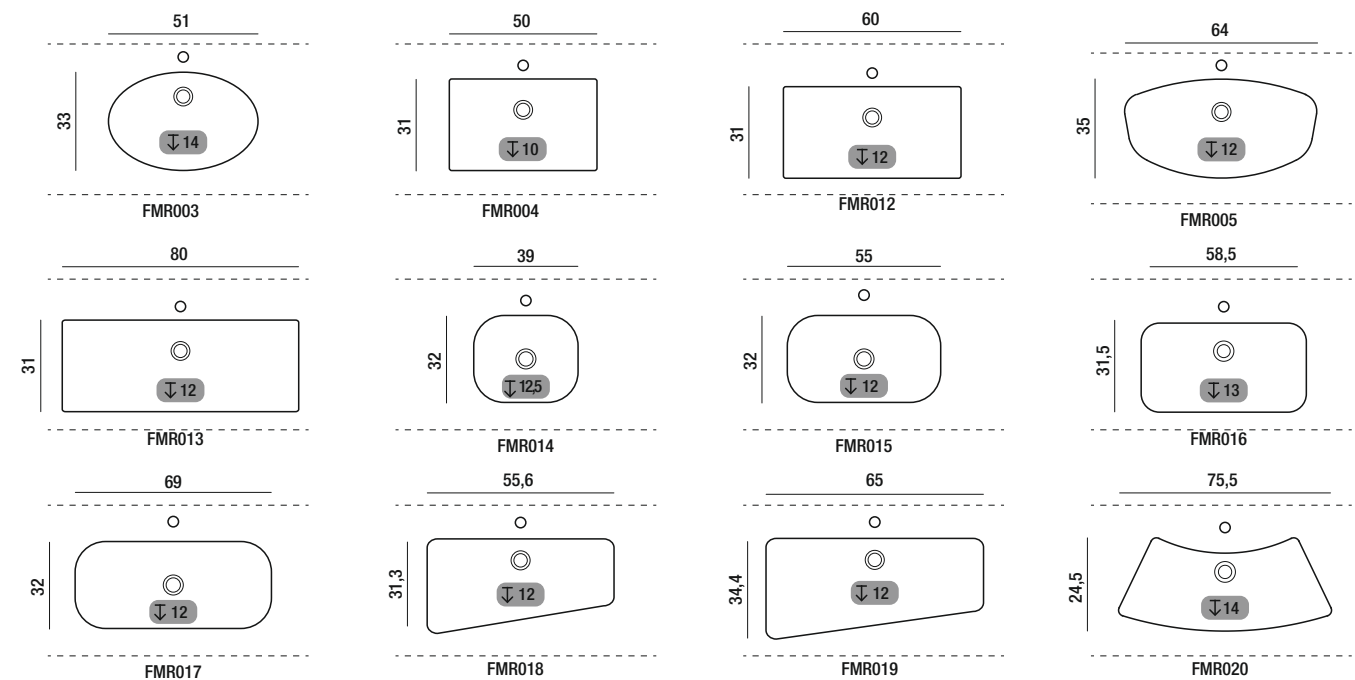

VASCHE PER PIANI PROF. 46 IN VETRO BASINS FOR 46-CM DEEP GLASS TOPS. VASQUES POUR PLANS PROF. 46 EN VERRE.

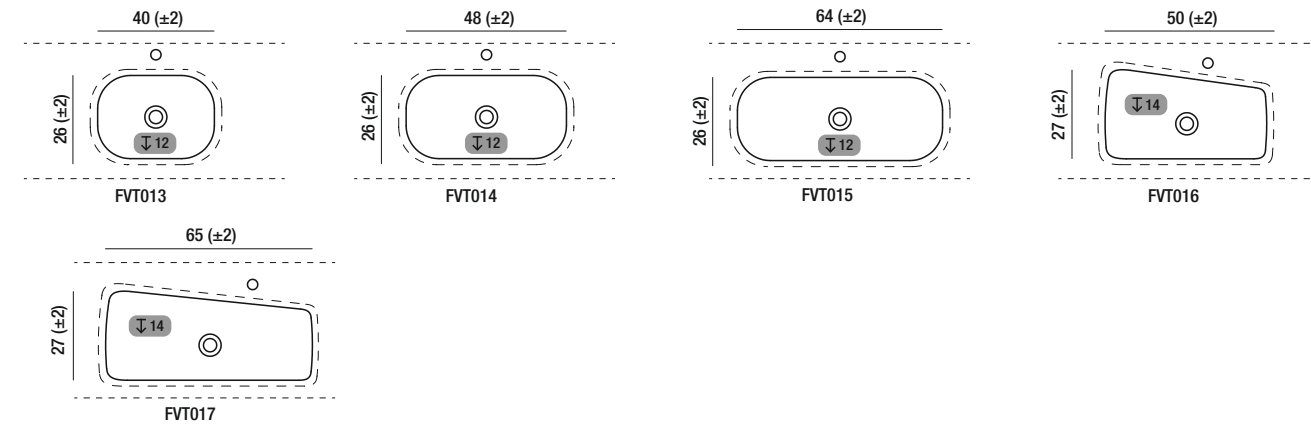

VASCHE INTEGRATE IN ECOMALTA PROF. 46 E 51,5 INTEGRATED BASINS IN ECOMALTA D.46 AND 51,5. VASQUES INTÉGRÉES EN ECOMALTA PROF. 46 ET 51,5.

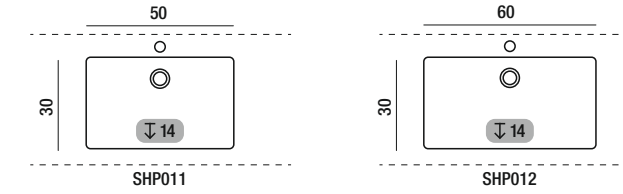

VASCHE PER PIANI PROF. 51,5 IN VETRO BASINS FOR 51,5-CM DEEP GLASS TOPS. VASQUES POUR PLANS PROF. 51,5 EN VERRE.

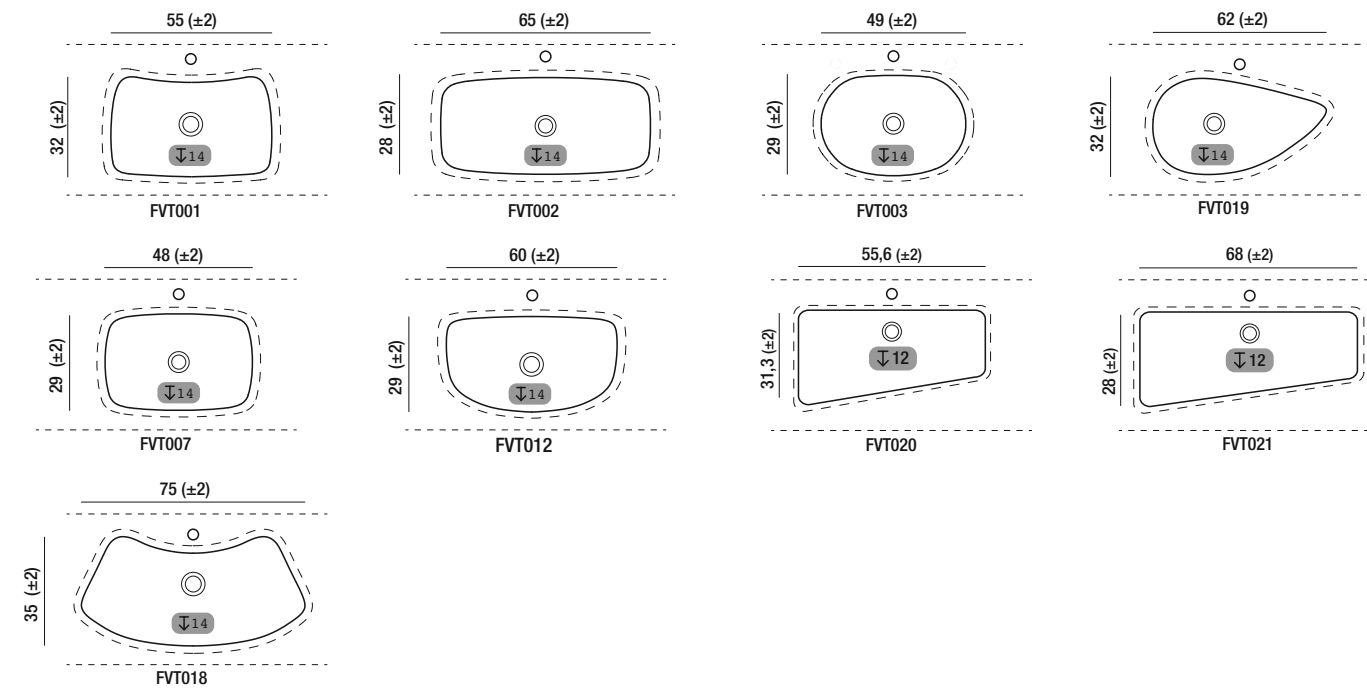

VASCHE PER PIANI PROF. 46,5 E PROF. 51,5 IN OCRITEC BASINS FOR 51,5-CM DEEP OCRITEC TOPS. VASQUES POUR PLANS PROF. 51,5 EN OCRITEC

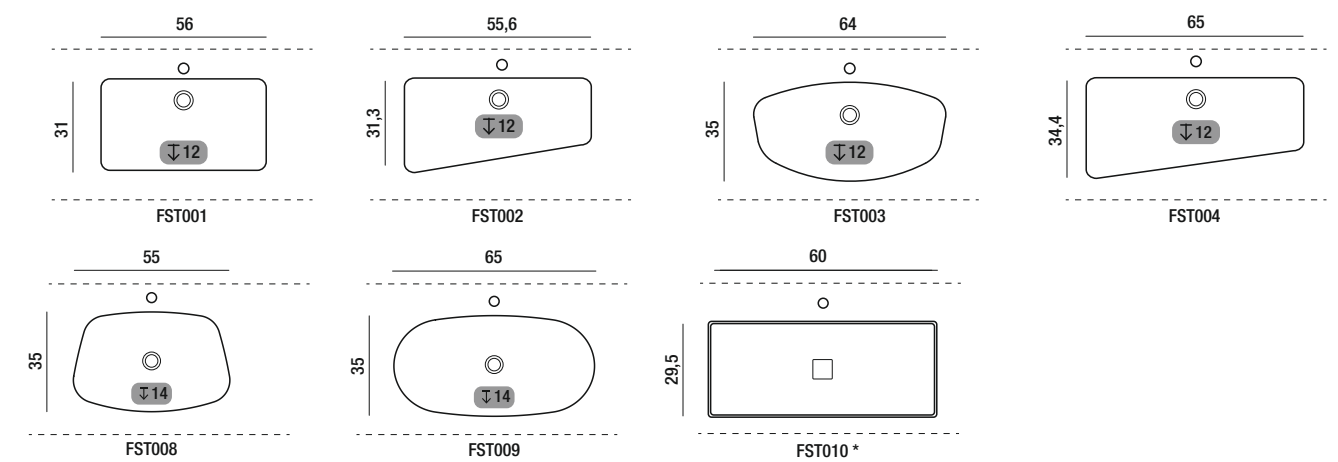

* PROF. 46,5 E PROF. 51,5 D.46,5 AND D.51,5. PROF. 46,5 ET PROF. 51,5.

VASCHE PER PIANI PROF. 51,5 IN QUARZO E TATUM BASINS FOR 51,5-CM DEEP QUARTZ AND TATUM TOPS. VASQUES POUR PLANS PROF. 51,5 EN QUARTZ ET TATUM.

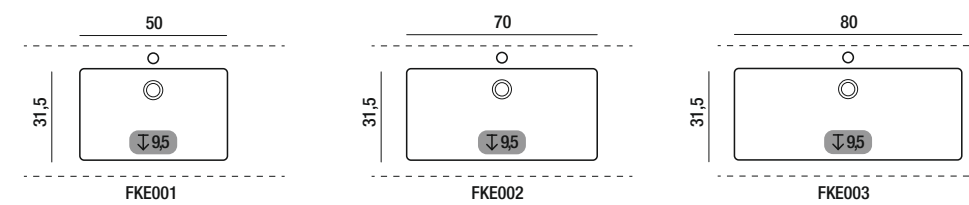

LAVATOI PER PIANI PROF. 46,5 E PROF. 51,5 IN OCRITEC LAUNDRY BASINS FOR 51,5 CM DEEP OCRITEC TOPS. BACS À LAVER POUR PLANS PROF. 51,5 EN OCRITEC.

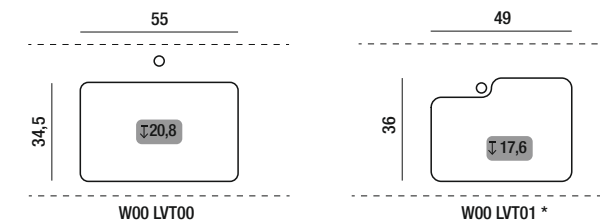

* PROF. 46,5 E PROF. 51,5 D.46,5 AND D.51,5. PROF. 46,5 ET PROF. 51,5.

Design: ??
A.D.: ??
Foto: **Photografica**
Stylist: **Cristina Chinellato**
Fotolito: **GM Studio 1**
Stampa: **Grafiche Peruzzo**

Si ringrazia: **Arketipo**
Twils
Tramonti design
Neo' design art

Cerasa

Cerasa Spa Via Borgo Nobili, 19 - 31010 Bibano di Godega di Sant'Urbano (TV) Italy Tel +39 0438 - 783411 Fax +39 0438 783450 www.cerasa.it - info@cerasa.it